

LogiCORE IP Integrated Bit Error Ratio Tester 7 Series GTZ Transceivers v3.0

***Product Guide for Vivado
Design Suite***

PG171 June 19, 2013

Table of Contents

IP Facts

Chapter 1: Overview

| | |
|--|---|
| Functional Description | 5 |
| Feature Summary | 5 |
| Applications | 8 |
| Licensing and Ordering Information | 8 |

Chapter 2: Product Specification

| | |
|--------------------------------|----|
| Performance | 9 |
| Resource Utilization | 9 |
| Port Descriptions | 10 |

Chapter 3: Designing with the Core

| | |
|-------------------------------------|----|
| General Design Guidelines | 11 |
| Clocking | 11 |
| Resets | 12 |

Chapter 4: Customizing and Generating the Core

| | |
|--|----|
| Vivado Integrated Design Environment | 13 |
| Output Generation | 19 |

Chapter 5: Constraining the Core

| | |
|--------------------------------|----|
| Required Constraints | 20 |
|--------------------------------|----|

Appendix A: Debugging

| | |
|--------------------------------------|----|
| Finding Help on Xilinx.com | 21 |
| Debug Tools | 23 |

Appendix B: Additional Resources

| | |
|----------------------------|----|
| Xilinx Resources | 24 |
| References | 24 |
| Revision History | 24 |

Notice of Disclaimer..... 25

Introduction

The customizable LogiCORE™ IP Integrated Bit Error Ratio Tester (IBERT) core for 7 series FPGA GTZ transceivers is designed for evaluating and monitoring the GTZ transceivers. This core includes pattern generators and checkers that are implemented in FPGA logic, and access to ports and the dynamic reconfiguration port attributes of the GTZ transceivers.

Communication logic is also included to allow the design to be run time accessible through JTAG. This core can be used as a self-contained or open design, based on customer configuration, and as described in this document.

Features

- Provides a communication path between the Vivado® serial I/O analyzer feature and the IBERT core
- Provides a user-selectable number of 7 series FPGA GTZ transceivers
- Transceivers can be customized for the desired line rate, reference clock rate, reference clock source, and datapath width
- Requires a system clock that can be sourced from a pin or one of the enabled GTZ transceivers

| LogiCORE IP Facts Table | |
|---|---------------------------------|
| Core Specifics | |
| Supported Device Family ⁽¹⁾ | Virtex®-7 |
| Supported User Interfaces | N/A |
| Resources | See Table 2-1 . |
| Provided with Core | |
| Design Files | RTL |
| Example Design | Verilog |
| Test Bench | Not Provided |
| Constraints File | XDC |
| Simulation Model | Not Provided |
| Supported S/W Driver | N/A |
| Tested Design Flows⁽²⁾ | |
| Design Entry | Vivado Design Suite |
| Simulation | Not Provided |
| Synthesis | Vivado Synthesis |
| Support | |
| Provided by Xilinx @ www.xilinx.com/support | |

Notes:

1. For a complete listing of supported devices, see the Vivado IP catalog.
2. For the supported versions of the tools, see the [Xilinx Design Tools: Release Notes Guide](#).

Overview

Functional Description

The IBERT core provides a broad-based Physical Medium Attachment (PMA) evaluation and demonstration platform for 7 series FPGA GTZ transceivers. Parameterizable to use different GTZ transceivers and clocking topologies, the IBERT core can also be customized to use different line rates, reference clock rates, and logic widths. Data pattern generators and checkers are included for each GTZ transceiver desired, giving several different Pseudo-random binary sequence (PRBS) and clock patterns to be sent over the channels.

In addition, the configuration and tuning of the GTZ transceivers is accessible through logic that communicates to the Dynamic Reconfiguration Port (DRP) port of the GTZ transceiver, in order to change attribute settings, as well as registers that control the values on the ports. At run time, the Vivado® serial I/O analyzer communicates to the IBERT core through JTAG, using the Xilinx cables and proprietary logic that is part of the IBERT core.

Feature Summary

The IBERT core is designed for PMA evaluation and demonstration. All the major PMA features of the GTZ transceiver are supported and controllable, including:

- TX pre-emphasis and post-emphasis
- TX differential swing
- RX equalization
- Phase-Locked Loop (PLL) divider settings

Some of the Physical Coding Sublayer (PCS) features offered by the transceiver are outside the scope of IBERT, including:

- Clock Correction
- Channel Bonding
- 8B/10B, 64B/66B, or 64B/67B encoding
- TX or RX Buffer Bypass

PLL Configuration

For each serial transceiver, two LC tank PLLs are present, one for RX, and one for TX. There are no shared PLLs amongst channels in the OCTAL.

Figure 1-1 shows a GTZ OCTAL in a 7 series device. The GTZ channels has the serial transceiver and CPLL units.

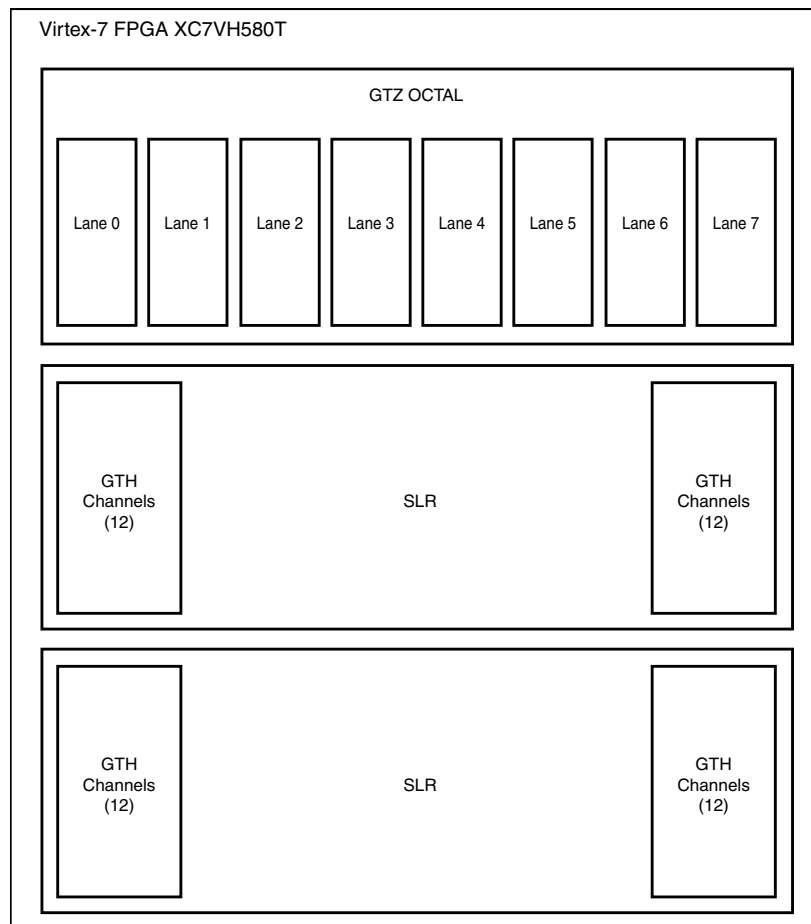

Figure 1-1: GTZ OCTAL in a Virtex-7 FPGA XC7VH580T

The serial transceiver REFCLK can be sourced from either of two inputs, with a multiplexer as shown in [Figure 1-2](#). This can be selected from the 7 series FPGA IBERT Vivado IP Catalog.

Each OCTAL has two REFCLK inputs and attributes control which REFCLK is used for each channel. The IBERT 7 series GTZ core only supports one line rate per OCTAL.

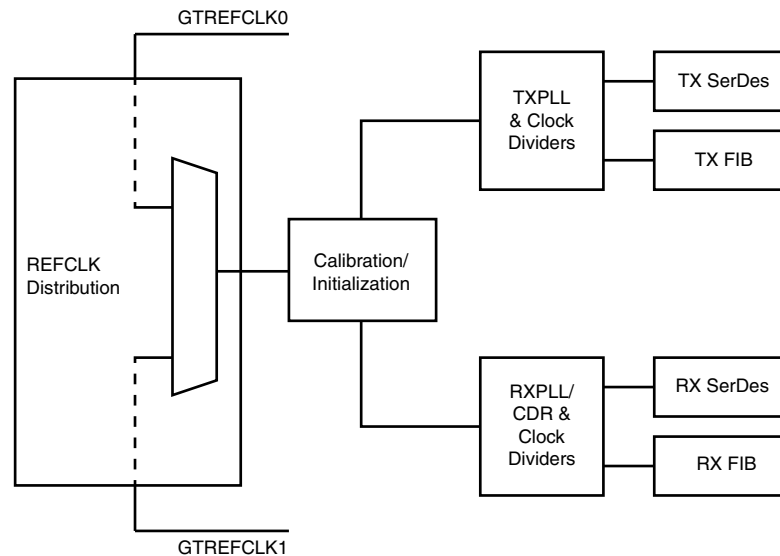

Figure 1-2: GTZ Internal Clocking Architecture

Pattern Generation and Checking

Each GTZ transceiver enabled in the IBERT design has a pattern generator and a pattern checker. The pattern generator sends data out through the transmitter. The pattern checker accepts data through the receiver and checks it against an internally generated pattern. IBERT offers PRBS 7-bit, PRBS 15-bit, PRBS 23-bit, PRBS 31-bit, Clk 2x (101010...), and Clk 10x (11111111110000000000...) patterns.

These patterns are optimized for the logic width that was selected at run time. The TX and RX patterns are individually selected.

Using the pattern checker logic, the incoming data is compared against a pattern that is internally generated. When the checker receives five consecutive cycles of data with no errors, the `LINK` signal is asserted. If the `LINK` signal is asserted and the checker receives five consecutive cycles with data errors, the `LINK` signal is deasserted. Internal counters accumulate the number of words and errors received.

DRP and Port Access

You can change GTZ transceiver ports and attributes. The DRP interface logic allows the run time software to monitor and change any attribute of the GTZ OCTAL. When applicable, readable and writable registers are also included that are connected to the various ports of the GTZ OCTAL. All are accessible at run time using the Vivado serial I/O analyzer.

Applications

The IBERT core is designed to be used in any application that requires verification or evaluation of 7 series FPGA GTZ transceivers.

Licensing and Ordering Information

This Xilinx LogiCORE IP module is provided at no additional cost with the Xilinx Vivado Design Suite tool under the terms of the [Xilinx End User License](#).

Information about this and other Xilinx LogiCORE IP modules is available at the [Xilinx Intellectual Property](#) page. For information on pricing and availability of other Xilinx LogiCORE IP modules and tools, contact your [local Xilinx sales representative](#).

Product Specification

Performance

The IBERT core can be configured to run any of the allowable line rates for the GTZ transceivers. See the *7 Series FPGAs Overview* ([DS180](#)) for the line rates supported by speed grade.

Maximum Frequencies

The IBERT core can operate at the maximum user clock frequencies for the FPGA logic width/speed grade selected. The maximum system clock rate is 100 MHz and the generated design divides any incoming system clock to adhere to this constraint.

Resource Utilization

Resources required for the IBERT 7 series GTZ transceiver core have been estimated for the 7 series XC7VH580T-HCG1155-2 FPGA ([Table 2-1](#)). These values were generated using Vivado® IP Catalog. They are derived from post-synthesis reports, and might change during place and route.

Table 2-1: 7 Series FPGAs Resource Estimates

| IBERT Setup | | | Device Resources | | | | Performance |
|------------------|------------------------|--------------|------------------|------------|------------|------------|------------------------|
| Line Rate (Gb/s) | Refclk Frequency (MHz) | No. of OCTAL | LUTs | Flip-Flops | DSP Slices | Block RAMs | F _{Max} (MHz) |
| 27.953 | 291.172 | 1 | 15,543 | 18,474 | 0 | 0 | 149.815 |
| 10.313 | 322.266 | 1 | 15,543 | 18,474 | 0 | 0 | 149.815 |

Port Descriptions

The I/O signals of the IBERT core consist only of the GTZ transceiver reference clocks, the GTZ transceiver transmit and receive pins, and a system clock (optional).

Table 2-2: IBERT I/O Signals

| Signal Name | I/O | Description |
|----------------------|-----|---|
| sysclk_i | I | Clocks all communication logic. This port is present only when an external clock is selected in the generator. |
| txp_o[n - 1:0] | O | Transmit differential pairs for each of the n GTZ transceivers used. |
| txn_o[n - 1:0] | | |
| rxn_i[n - 1:0] | I | Receive differential pairs for each of the n GTZ transceivers used. |
| rxp_i[n - 1:0] | | |
| gtrefclk0_i[n - 1:0] | I | GTZ transceiver reference clocks used. The number of MGTREFCLK ports can be equal to or less than the number of transmit and receive ports because some GTZ transceivers can share clock inputs. |
| gtrefclk1_i[n - 1:0] | | |

Designing with the Core

This chapter includes guidelines and additional information to facilitate designing with the core.

General Design Guidelines

Line Rate Support

IBERT supports one line rate per OCTAL. A list of the supported line rates is available, and for each line rate, one or more reference clock rates are supported. The proper divider settings is specified for each line rate/reference clock rate combination.

Serial Transceiver Location

Based on the total number of serial transceivers selected, provide the specific location of each serial transceiver that you intend to use. The region shown in the panel indicates the location of serial transceivers in the tile. This demarcation of region is based on the physical placement of serial transceivers with respect to median of BUFGs available for each device. Depending on the device selected, one or two OCTALs are available. The region shown in the panel indicates the location of the OCTAL in the device.

Clocking

System Clock

When you choose different system clock locations while customizing the IBERT GTZ IP, you have to modify the `local.xdc` file to update the `BUFGTCTRL LOC` for the constraint and the cell `u_bu fg_dcl k` to match the System Package Pin location (making sure the `SYSCLK` location and BUFG (compatible to GTZ `DRPCLK` only) are both in top/bottom region of an SLR region).

The IBERT core requires a free-running system clock for communication and other logic that is included in the core. This clock can be chosen at generation time to originate from an FPGA pin, or to be driven from the TXOUTCLK port of one of the GTZ transceivers. In order for the core to operate properly, this system clock source must remain operational and stable when the FPGA is configured with the IBERT core design.

If the system clock is running faster than 100 MHz, it is divided down internally using a Mixed-Mode Clock Manager (MMCM) to satisfy timing constraints. The clock source selected must be stable and free running after the FPGA is configured with the IBERT design. The system clock is used for core communication and as a reference for system measurements. Therefore, the clock source selected must remain operational and stable when using the IBERT core.

Receiver Output Clock

The receiver clock probe enable is provided to pull out a recovered clock from any serial transceiver, if desired. When enabled, a new panel appears just before the summary page where you can fill in the serial transceiver source and probe pin standards.

Reference Clock

The reference clock source should be provided for all the serial transceivers selected. The drop-down list provides you with possible sources based on local clocks in the same quad.

Resets

Run time resets are available for the BERT counters and all GT resets are available.

Customizing and Generating the Core

This chapter includes information about using Xilinx tools to customize and generate the core in the Vivado® Design Suite environment.

Vivado Integrated Design Environment

The Vivado IP catalog allows you to define and generate a customized IBERT core to use to validate the transceivers of the device. You can customize the number of serial transceivers, line rate and reference clock, and PLL selection for each serial transceiver.

The IBERT core can be found in `/Debug & Verification/Debug/` in the Vivado IP Catalog.

To access the core name, perform the following:

1. Open a project by selecting **File** then **Open Project** or create a new project by selecting **File** then **New Project** in Vivado.
2. Open the IP catalog and navigate to any of the taxonomies.
3. Double-click **IBERT 7 Series GTZ** to bring up the IBERT Customize IP dialog box.

[Figure 4-1](#) to [Figure 4-5](#) show the IBERT Customize IP dialog boxes with information about customizing ports.

Entering the Component Name

The Component Name field can consist of any combination of alpha-numeric characters including the underscore symbol. However, the underscore symbol cannot be the first character in the component name.

Design Options

- **Board Configuration Settings (BCS)** – Generates bit file for Super Clock II along with IBERT design to set the REFCLK frequencies on GTZ boards.
- **System Clock** – Options to set the frequency, input standard, and P/N pin locations.
 - **Frequency** – Range of 50 to 500.
 - **Input Standard** – BLVDS 25.
 - **P Pin Location** – Specify a valid pin location, such as Unconstrained.
 - **N Pin Location** – Specify a valid pin location, such as Unconstrained.
- **Add RXOUTCLK Probe Checkbox** – Enables the RXOUTCLK panel for entering the output pin locations for RXOUTCLK.
- **Silicon Version** – Only Initial ES is supported.

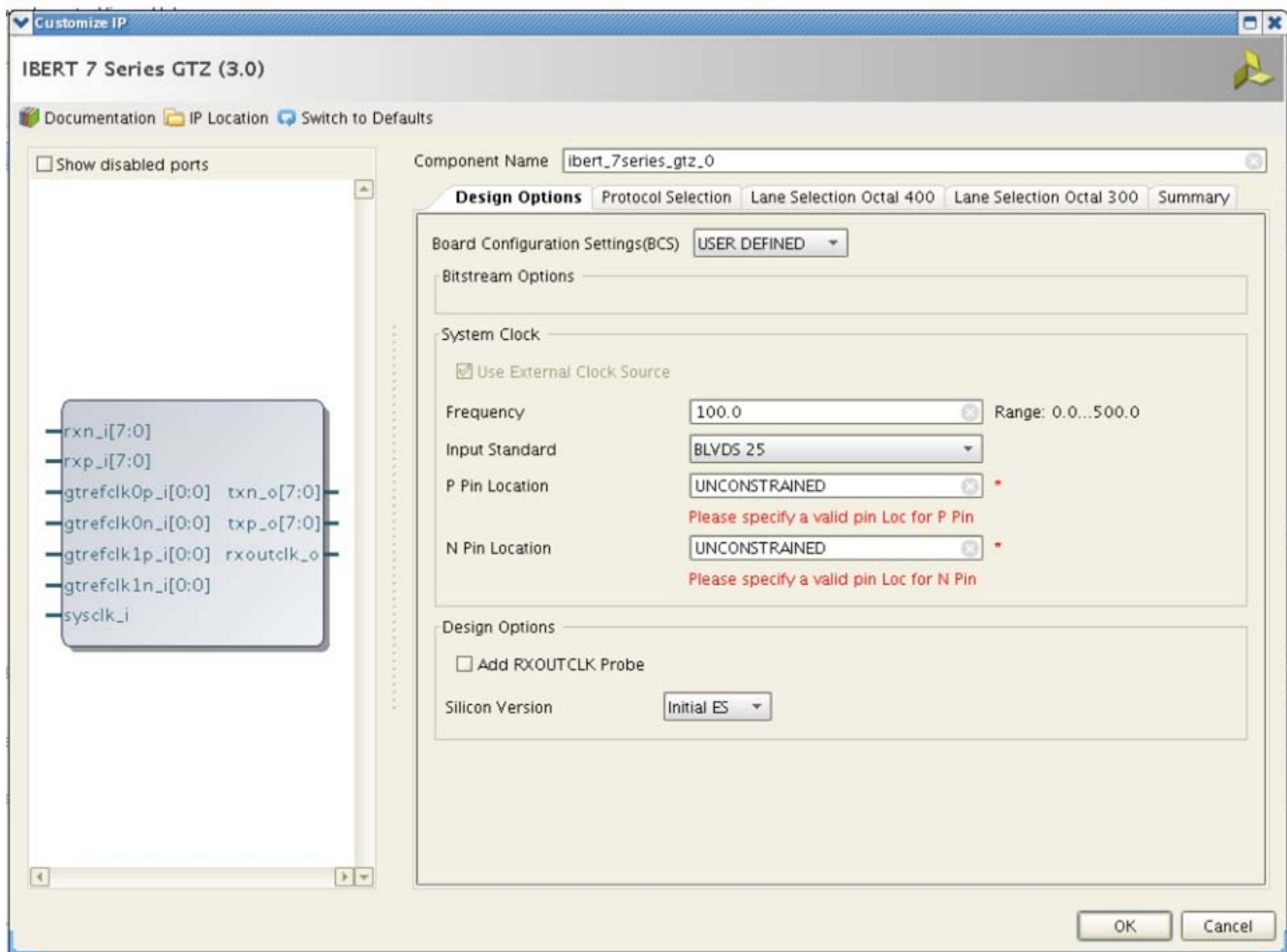

Figure 4-1: Vivado Customize IP Dialog Box – Design Options

Protocol Selection

A protocol is a line rate, data width, reference clock rate, lane count, and reference clock source. For an IBERT GTZ core, the transceiver selection is on a lane basis. For each protocol, eight or 16 lanes are allowed (one OCTAL or two OCTALS).

1. Choose the number of protocols desired.
2. In the Protocol combination box, select a Pre-defined protocol.
 - a. Select the line rate and data width. IBERT supports one line rate per OCTAL.
 - b. Choose the REFCLK rate and lane count of 8 or 16.
3. Select the REFCLK source.

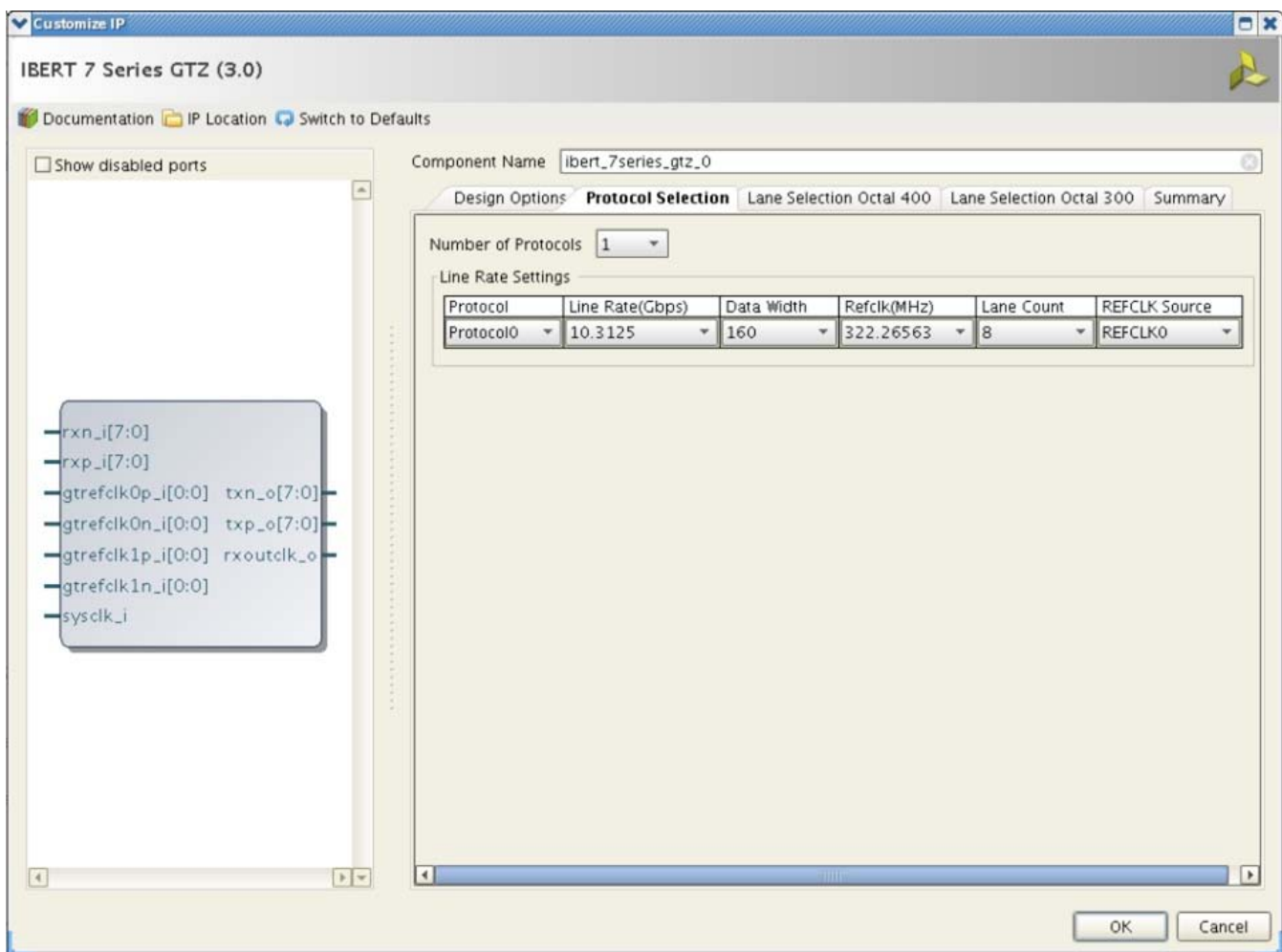

Figure 4-2: Vivado Customize IP Dialog Box – Protocol Selection

Lane Selection OCTAL 400/Lane Selection OCTAL 300

- **Location** – Specifies the lane location.
- **Protocol** – Specification for the OCTAL based on availability in the part.
- **Power Down for Each Lane** – This option powers down the specific transceiver while the design is running on hardware.
- **Resource Usage** – BUFG count is at 2.

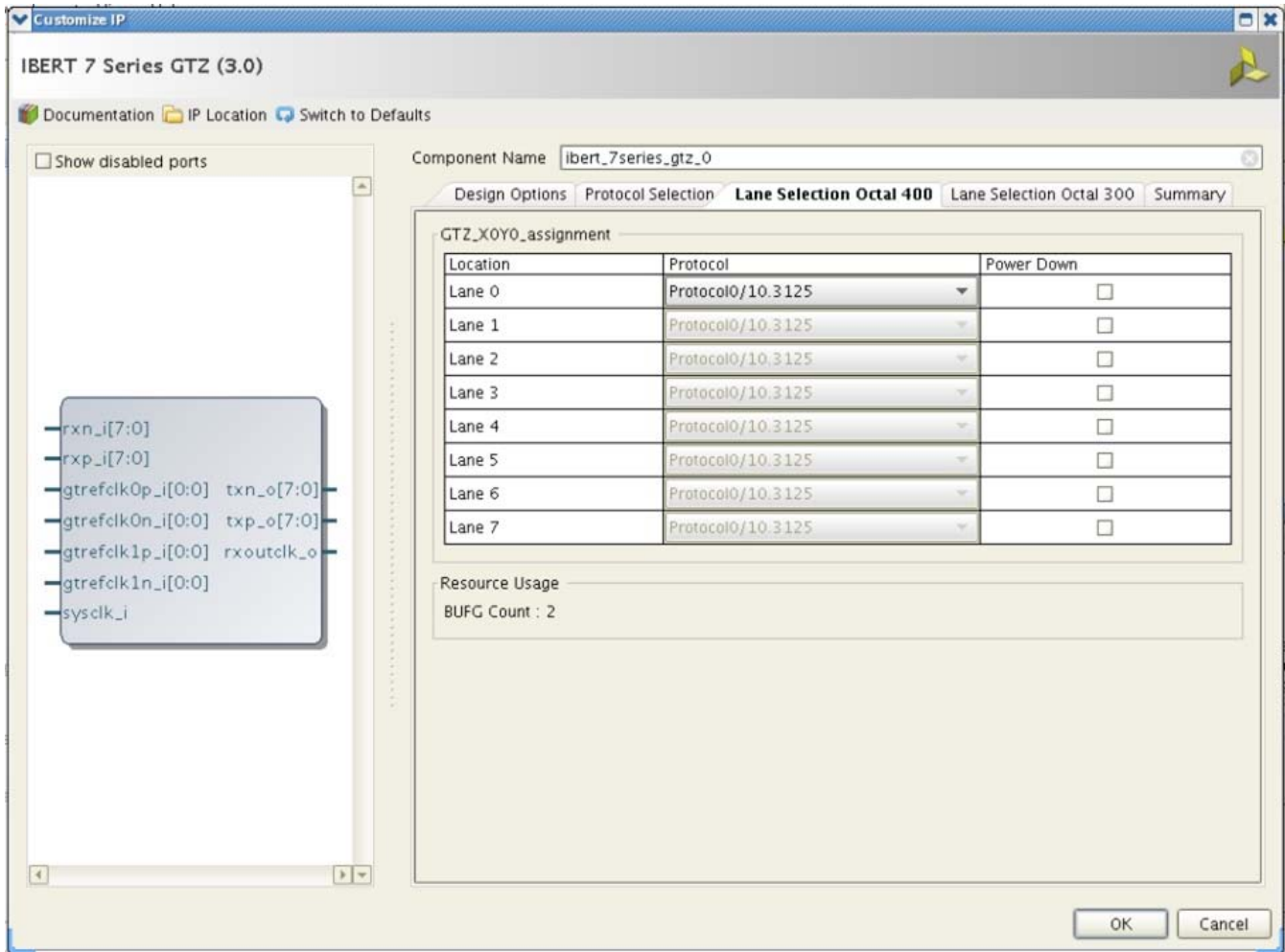

Figure 4-3: Vivado Customize IP Dialog Box – Lane Selection OCTAL 400/Lane Selection OCTAL 300

RXOUTCLK Source Selection

When the checkbox **Add RXOUTCLK Probe** is enabled, this panel is shown (hidden if disabled). This page allows you to provide the I/O pin locations for RXOUTCLK that is given in the design.

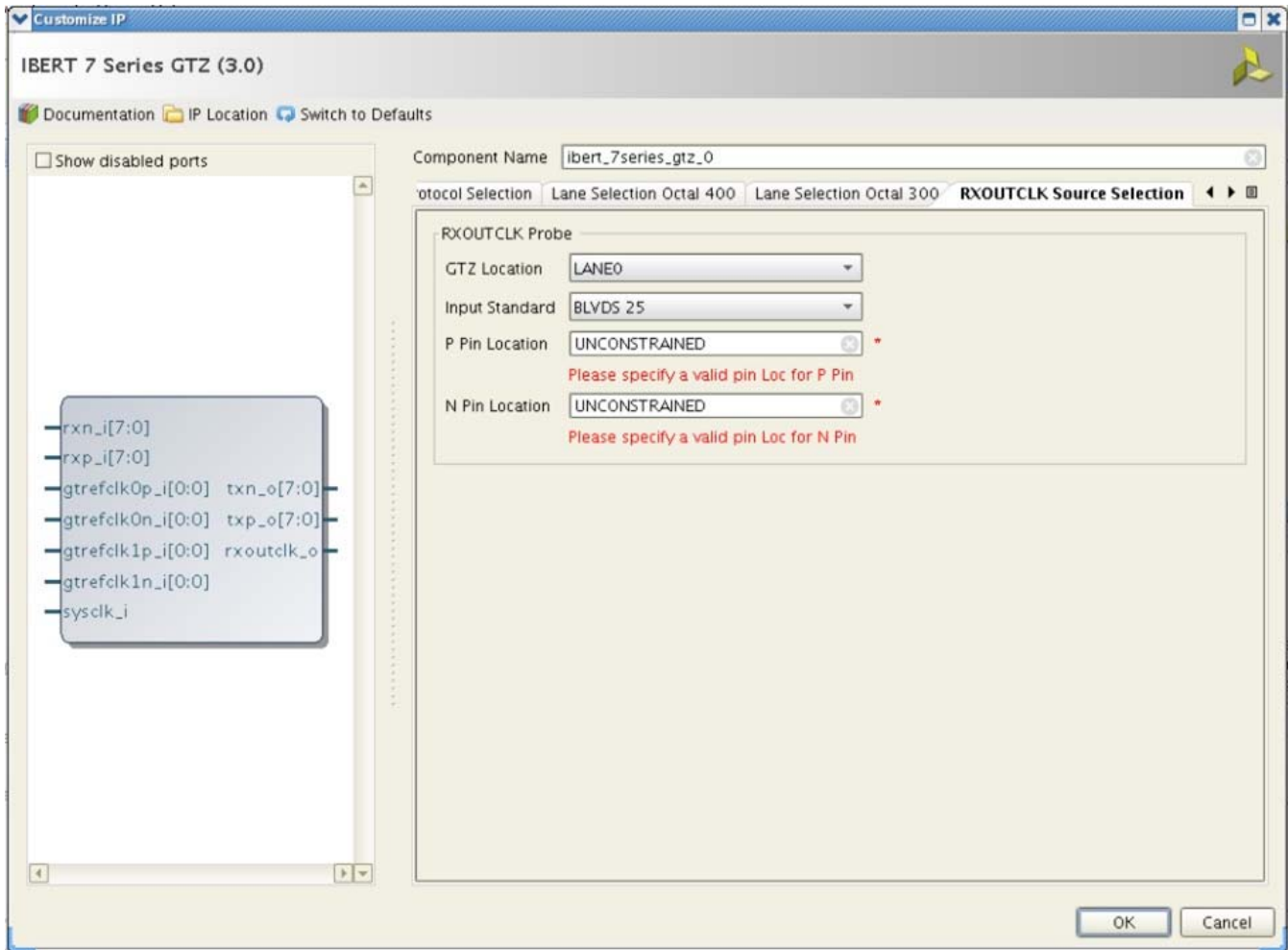

Figure 4-4: Vivado Customize IP Dialog Box – RXOUTCLK Source Selection

Summary

Review the settings chosen in the summary page and if they are satisfactory, click **OK** to generate the IBERT core.

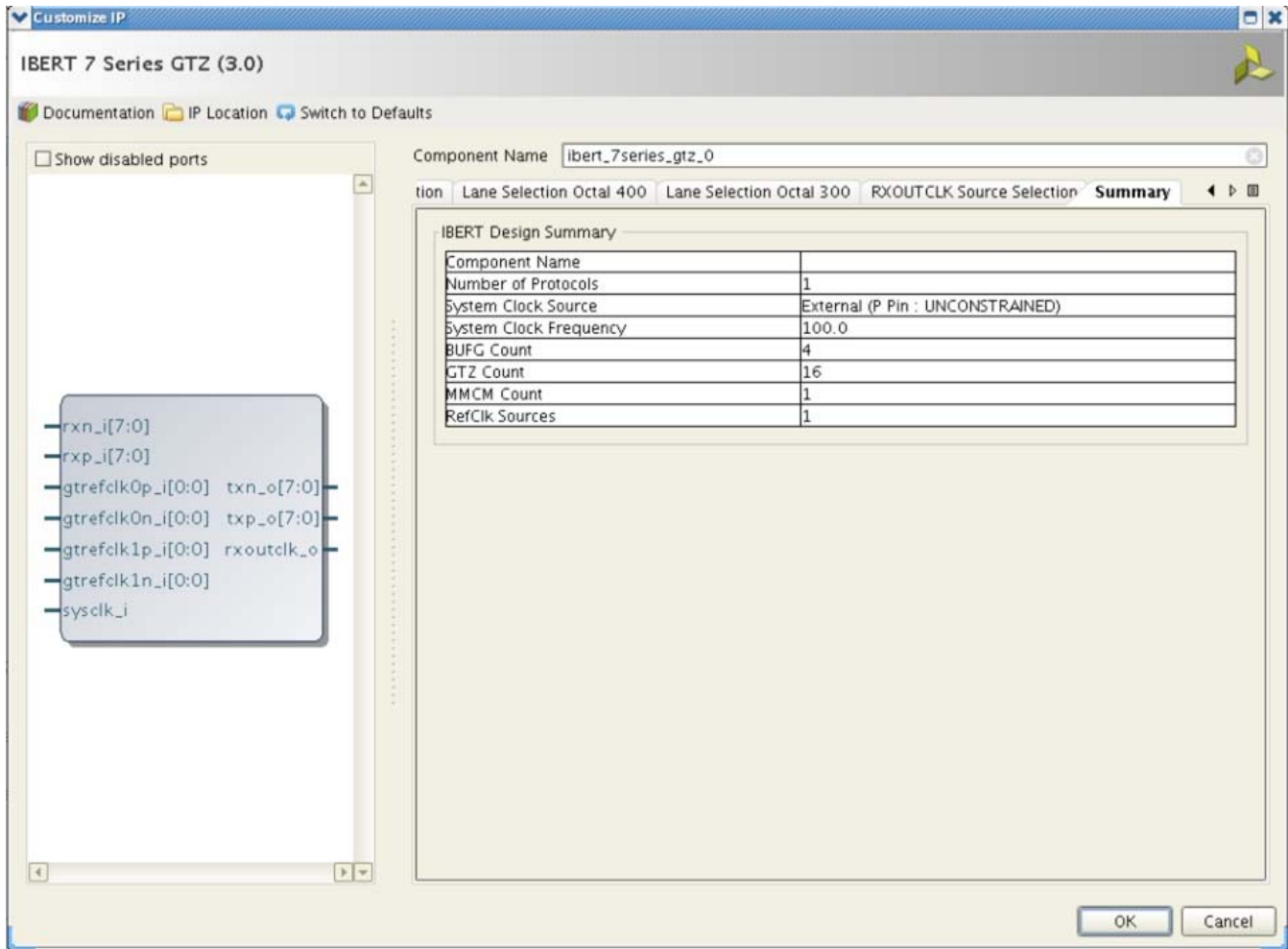

Figure 4-5: Vivado Customize IP Dialog Box – Summary

Output Generation

This section provides detailed information about the files and the directory structure generated by the Xilinx Vivado tool.

The output files generated from the Xilinx Vivado IP catalog are placed in the project directory. The file output list might include some or all of the following files.

Generating an Example Design

See Chapter 7 of the *Vivado Design Suite User Guide, Programming and Debugging* ([UG908](#)).

Debugging the Serial I/O Design in Hardware

See Chapter 8 of the *Vivado Design Suite User Guide, Programming and Debugging* ([UG908](#)).

Generating the Core

-  **<project directory>**
Top-level project directory; name is user-defined (for instance, `ibert_7series_gtz_v3_0_0_example`)
 -  **<project directory>/<project_name.srcs>**
 -  **<project_name.srcs> /sources_1**
 -  **sources_1/imports**
 -  **sources_1/ip**
Contains IP sources
 -  **<project_name.srcs> /constrs_1**
 -  **constrs_1/imports**
 -  **imports/example_design**
XDC constraints files

Constraining the Core

This chapter contains information about constraining the core in the Vivado® Design Suite environment.

Required Constraints

The IBERT GTZ core is generated with its own timing and location constraints, based on the choices the user made when customizing the core. No additional constraints are required.

Debugging

This appendix includes details about resources available on the Xilinx Support website and debugging tools. In addition, this appendix provides a step-by-step debugging process to guide you through debugging the IBERT 7 series GTZ transceivers core.

Finding Help on Xilinx.com

To help in the design and debug process when using the IBERT 7 series GTZ transceivers, the [Xilinx Support web page](http://www.xilinx.com/support) (www.xilinx.com/support) contains key resources such as product documentation, release notes, answer records, information about known issues, and links for opening a Technical Support WebCase.

Documentation

This product guide is the main document associated with the IBERT 7 series GTZ transceivers. This guide, along with documentation related to all products that aid in the design process, can be found on the Xilinx Support web page (www.xilinx.com/support) or by using the Xilinx Documentation Navigator.

Download the Xilinx Documentation Navigator from the Design Tools tab on the Downloads page (www.xilinx.com/download). For more information about this tool and the features available, open the online help after installation.

Answer Records

Answer Records include information about commonly encountered problems, helpful information on how to resolve these problems, and any known issues with a Xilinx product. Answer Records are created and maintained daily ensuring that users have access to the most accurate information available.

Answer Records for this core are listed below, and can also be located by using the Search Support box on the main [Xilinx support web page](#). To maximize your search results, use proper keywords such as

- Product name
- Tool message(s)
- Summary of the issue encountered

A filter search is available after results are returned to further target the results.

Master Answer Record for the IBERT 7 Series GTZ Transceivers

AR [54607](#)

Contacting Technical Support

Xilinx provides technical support at www.xilinx.com/support for this LogiCORE™ IP product when used as described in the product documentation. Xilinx cannot guarantee timing, functionality, or support of product if implemented in devices that are not defined in the documentation, if customized beyond that allowed in the product documentation, or if changes are made to any section of the design labeled DO NOT MODIFY.

To contact Xilinx Technical Support:

1. Navigate to www.xilinx.com/support.
2. Open a WebCase by selecting the [WebCase](#) link located under Support Quick Links.

When opening a WebCase, include:

- Target FPGA including package and speed grade.
- All applicable Xilinx Design Tools and simulator software versions.
- Additional files based on the specific issue might also be required. See the relevant sections in this debug guide for guidelines about which file(s) to include with the WebCase.

Debug Tools

There are many tools available to address IBERT 7 series GTZ transceivers design issues. It is important to know which tools are useful for debugging various situations.

Vivado Lab Tools

Vivado[®] lab tools insert logic analyzer and virtual I/O cores directly into your design. Vivado lab tools allows you to set trigger conditions to capture application and integrated block port signals in hardware. Captured signals can then be analyzed. This feature represents the functionality in the Vivado IDE that is used for logic debugging and validation of a design running in Xilinx devices in hardware.

The Vivado logic analyzer is used to interact with the logic debug LogiCORE IP cores, including:

- ILA 2.0 (and later versions)
- VIO 2.0 (and later versions)

License Checkers

If the IP requires a license key, the key must be verified. The Vivado design tools have several license checkpoints for gating licensed IP through the flow. If the license check succeeds, the IP can continue generation. Otherwise, generation halts with error. License checkpoints are enforced by the following tools:

- Vivado Synthesis
- Vivado Implementation
- Vivado logic analyzer
- write_bitstream (Tcl command)



IMPORTANT: *IP license level is ignored at checkpoints. The test confirms a valid license exists. It does not check IP license level.*

Additional Resources

Xilinx Resources

For support resources such as Answers, Documentation, Downloads, and Forums, see the Xilinx Support website at:

www.xilinx.com/support.

For a glossary of technical terms used in Xilinx documentation, see:

www.xilinx.com/company/terms.htm.

References

These documents provide supplemental material useful with this product guide:

1. *Vivado[®] Design Suite User Guide, Programming and Debugging* ([UG908](#))
 2. *7 Series FPGAs Overview* ([DS180](#))
 3. [Vivado Design Suite user documentation](#)
 4. *Vivado Design Suite User Guide, Designing with IP* ([UG896](#))
 5. *Vivado Design Suite Migration Methodology Guide* ([UG911](#))
-

Revision History

The following table shows the revision history for this document.

| Date | Version | Revision |
|------------|---------|--|
| 06/19/2013 | 3.0 | <ul style="list-style-type: none"> • Initial Xilinx public release of document in product guide format. Replaces DS878. • Revision number advanced to 3.0 to align with core version number. |

Notice of Disclaimer

The information disclosed to you hereunder (the "Materials") is provided solely for the selection and use of Xilinx products. To the maximum extent permitted by applicable law: (1) Materials are made available "AS IS" and with all faults, Xilinx hereby DISCLAIMS ALL WARRANTIES AND CONDITIONS, EXPRESS, IMPLIED, OR STATUTORY, INCLUDING BUT NOT LIMITED TO WARRANTIES OF MERCHANTABILITY, NON-INFRINGEMENT, OR FITNESS FOR ANY PARTICULAR PURPOSE; and (2) Xilinx shall not be liable (whether in contract or tort, including negligence, or under any other theory of liability) for any loss or damage of any kind or nature related to, arising under, or in connection with, the Materials (including your use of the Materials), including for any direct, indirect, special, incidental, or consequential loss or damage (including loss of data, profits, goodwill, or any type of loss or damage suffered as a result of any action brought by a third party) even if such damage or loss was reasonably foreseeable or Xilinx had been advised of the possibility of the same. Xilinx assumes no obligation to correct any errors contained in the Materials or to notify you of updates to the Materials or to product specifications. You may not reproduce, modify, distribute, or publicly display the Materials without prior written consent. Certain products are subject to the terms and conditions of the Limited Warranties which can be viewed at <http://www.xilinx.com/warranty.htm>; IP cores may be subject to warranty and support terms contained in a license issued to you by Xilinx. Xilinx products are not designed or intended to be fail-safe or for use in any application requiring fail-safe performance; you assume sole risk and liability for use of Xilinx products in Critical Applications: <http://www.xilinx.com/warranty.htm#critapps>.

© Copyright 2013 Xilinx, Inc. Xilinx, the Xilinx logo, Artix, ISE, Kintex, Spartan, Virtex, Vivado, Zynq, and other designated brands included herein are trademarks of Xilinx in the United States and other countries. All other trademarks are the property of their respective owners.