

Introduction

The LogiCORE™ IP Virtex®-5 FPGA Embedded Tri-Mode Ethernet MAC Wrapper automates the generation of HDL wrapper files for the Embedded Tri-Mode Ethernet MAC (Ethernet MAC) in Virtex-5 LXT, SXT, FXT and TXT FPGAs using the Xilinx CORE Generator™ software.

VHDL and Verilog® instantiation templates are available in the Libraries Guide for the Virtex-5 FPGA Ethernet MAC primitive; however, due to the complexity and large number of ports, the CORE Generator software simplifies integration of the Ethernet MAC by providing HDL examples based on user-selectable configurations.

Features

- Allows selection of one or both Ethernet MACs (EMAC0/EMAC1) from the Ethernet MAC primitive
- Sets the EMAC0/EMAC1 attributes based on user options
- Provides user-configurable Ethernet MAC physical interfaces
 - Supports MII, GMII, RGMII v1.3, RGMII v2.0, SGMII, and 1000BASE-X PCS/PMA interfaces
 - Instantiates clock buffers, DCMs, Virtex-5 FPGA RocketIO™ GTP or GTX transceivers, and logic as required for the selected physical interfaces
- Provides a simple FIFO-loopback example design, connected to the MAC client interfaces
- Provides a simple demonstration test bench based on the selected configuration
- Generates VHDL or Verilog

LogiCORE IP Facts	
Supported FPGA Family	Virtex-5
Performance	10 Mbps, 100 Mbps, 1 Gbps
Example Design Resources	
LUTs	380-930 ¹
FFs	440-1220 ¹
Block RAMs	(18k) 4-10 ¹
DCM	0-1 ¹
BUFG	2-10 ¹
Wrapper Highlights	
Optimized Clocking Logic	HDL Example Design
Hardware Verified	Demonstration Test Bench
Provided with Wrapper	
Documentation	Product Specification Getting Started Guide User Guide ²
Design File Formats	HDL Example Design, Demonstration Test Bench, Scripts
Constraints File	User Constraints File (.ucf)
Example Designs	Example FIFO connected to Client I/F Demonstration Test Environment
Design Tool Requirements	
Supported HDL	VHDL and/or Verilog
Synthesis	XST 11.1
Xilinx Tools	ISE® 11.1
Simulation Tools ³	Mentor® ModelSim® 6.4b ⁴ Cadence® IUS v8.1 -s009 ⁴ Synopsys® VCS 2008.09 ⁴

1. The precise number depends on user configuration; see [Device Utilization](#).
2. Available from http://www.xilinx.com/support/documentation/ip_documentation/ug194.pdf.
3. Requires a Verilog LRM-IEEE 1364-2005 encryption-compliant simulator. For VHDL simulation, a mixed HDL license is required.
4. Scripts provided for listed simulators only.

Ethernet Architecture Overview

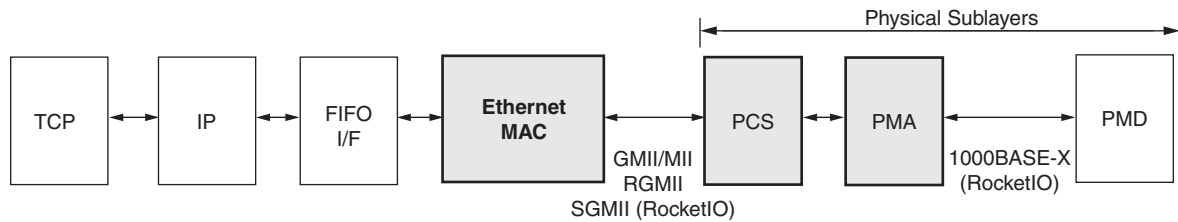

Figure 1: Typical Ethernet Architecture

Figure 1 displays the Ethernet MAC architecture from the MAC to the right, as defined in the *IEEE 802.3* specification, and also illustrates where the supported physical interfaces fit into the architecture.

MAC

The Ethernet MAC is defined in the *IEEE 802.3* specification clauses 2, 3, and 4. A MAC is responsible for the Ethernet framing protocols and error detection of these frames. The MAC is independent of, and can connect to, any type of physical sublayer.

GMII/MII

The Media Independent Interface (MII), defined in *IEEE 802.3* clause 22, is a parallel interface that connects a 10-Mbps and/or 100-Mbps capable MAC to the physical sublayers. The Gigabit Media Independent Interface (GMII), defined in *IEEE 802.3* clause 35, is an extension of the MII used to connect a 1-Gbps capable MAC to the physical sublayers. MII can be considered a subset of GMII, and as a result, GMII/MII can carry Ethernet traffic at 10 Mbps, 100 Mbps, and 1 Gbps.

RGMII

The Reduced-GMII (RGMII) is an alternative to GMII/MII. RGMII achieves a 50-percent reduction in the pin count, achieved by the use of double-data-rate (DDR) flip-flops. For this reason, RGMII is preferred over GMII by PCB designers. RGMII can carry Ethernet traffic at 10 Mbps, 100 Mbps, and 1 Gbps.

SGMII

The Serial-GMII (SGMII) interface is an alternative to GMII/MII. SGMII converts the parallel interface of the GMII/MII into a serial format using a RocketIO GTP or GTX transceiver, radically reducing the I/O count. For this reason, it is often the preferred interface of PCB designers. SGMII can carry Ethernet traffic at 10 Mbps, 100 Mbps, and 1 Gbps.

PCS, PMA, PMD

The combination of the Physical Coding Sublayer (PCS), the Physical Medium Attachment (PMA), and the Physical Medium Dependent (PMD) sublayer comprise the physical layers of the Ethernet protocol.

Two main physical standards are specified for Ethernet:

- BASE-T, a copper standard using twisted pair cabling systems
- BASE-X, usually a fibre optical physical standard using short and long wavelength laser

BASE-T devices, supporting 10 Mbps, 100 Mbps, and 1 Gbps Ethernet speeds, are readily available as off-the-shelf parts. As illustrated in Figures 1 and 2, these can be connected using GMII/MII, RGMII, or SGMII to provide a tri-speed Ethernet port.

The Ethernet MAC has built-in 1000BASE-X PCS/PMA functionality and can be connected to a RocketIO GTP or GTX transceiver to provide a 1 Gbps fibre optic port, as illustrated in Figure 3.

Applications

Typical applications for the Ethernet MAC core include

- Ethernet Tri-speed BASE-T Port
- Ethernet 1000BASE-X Port

Ethernet Tri-speed BASE-T Port

Figure 2 illustrates a typical application for a single Ethernet MAC. The PHY side of the core is implementing an external GMII/MII by connecting it to IOBs; the external GMII/MII is connected to an off-the-shelf Ethernet PHY device, which performs the BASE-T standard at 1 Gbps, 100 Mbps, and 10 Mbps speeds. Alternatively, the external GMII/MII can be replaced with an RGMII (as shown) or as an SGMII (which requires the use of a RocketIO GTP or GTX transceiver). GMII, RGMII, and SGMII functionality are demonstrated in the HDL examples provided with the example design.

The client side of the Ethernet MAC is shown connected to the 10 Mbps, 100 Mbps, 1 Gbps Ethernet FIFO (delivered with the example design) to complete a single Ethernet port. This port is displayed connected to a Switch or Routing matrix, which can contain several ports.

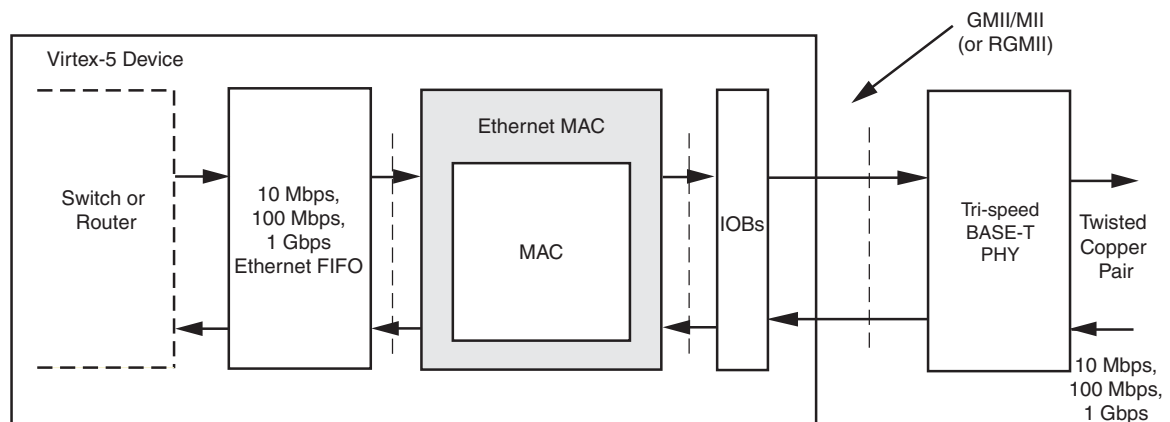

Figure 2: Typical 1000BASE-T Application

Ethernet 1000BASE-X Port

Figure 3 illustrates a typical application for a single Ethernet MAC. The PHY side of the MAC is connected to a RocketIO GTP or GTX transceiver, which in turn is connected to an external off-the-shelf GBIC or SFP optical transceiver. The 1000BASE-X logic can be optionally provided by the Ethernet MAC, as displayed. 1000BASE-X functionality is demonstrated in the HDL examples provided with the example design.

The client side of the Ethernet MAC is shown connected to the 10 Mbps, 100 Mbps, 1 Gbps Ethernet FIFO (delivered with the example design) to complete a single Gigabit Ethernet port. This port is connected to a Switch or Routing matrix, which can contain several ports.

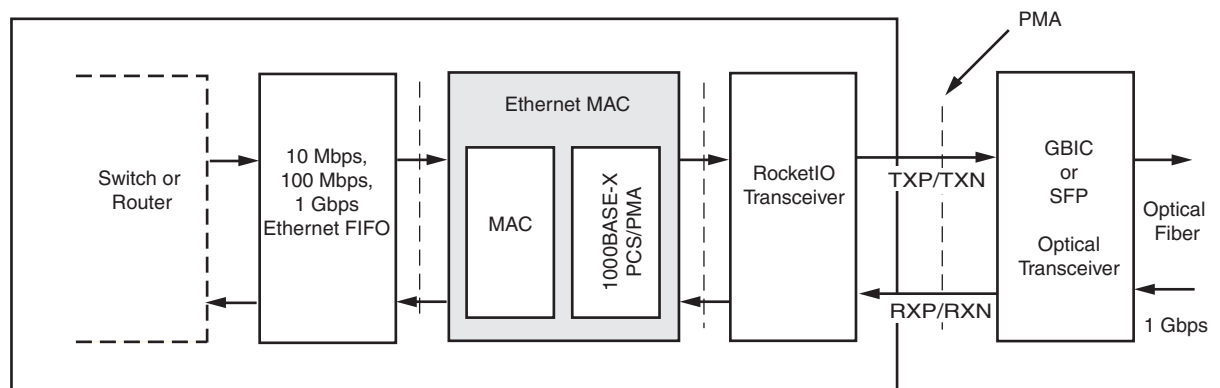

Figure 3: Typical 1000BASE-X Application

Example Design Overview

Figure 4 illustrates the major functional blocks of the Ethernet MAC example design. All illustrated components are provided in HDL, with the exception of the Ethernet MAC component.

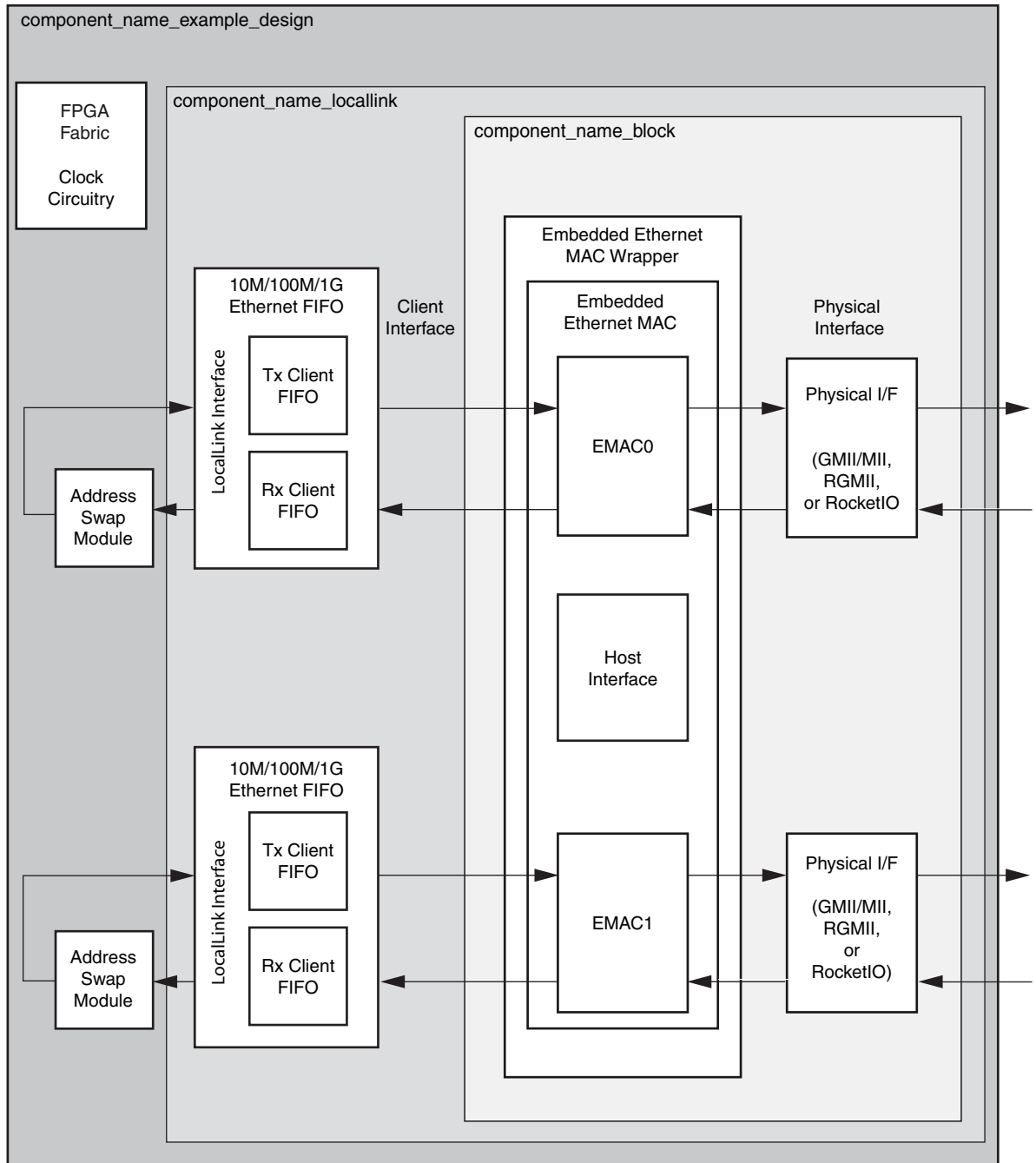

Figure 4: Example Design

Ethernet MAC Example Design

The example design is arranged for quick adaptation and can be downloaded onto an FPGA to provide a real hardware test environment. In addition, all the clock management logic required to operate the Ethernet MAC and its example design is provided. DCMs, BUFs, and so forth are instantiated as required.

The data is looped back at the client interface, enabling the Ethernet MAC to be quickly connected to a protocol tester—frames injected into the Ethernet MAC PHY Receive port are relayed back through the Ethernet MAC and out through the Ethernet MACs PHY Transmit port. Using this method, they are received back at the protocol tester.

The design includes an Address Swapping Module and a FIFO. Frames received by the Ethernet MAC are passed through the Receive side of the FIFO. Data from the Receive side of the FIFO is passed into the Address Swap Module and then on to the Transmit side of the FIFO using a LocalLink interface. The Transmit FIFO queues frames for transmission and connects directly to the client side Transmit interface of the Ethernet MAC.

Address Swap Module

The Address Swap Module switches the Destination Address and Source Address within the received MAC frame. Using this method, frames received from a link partner, for example a protocol tester, are relayed back to the correct Destination Address.

10 Mbps, 100 Mbps, 1 Gbps Ethernet FIFO

The 10 Mbps, 100 Mbps, 1 Gbps Ethernet FIFO is a wrapper file around the Receive and Transmit FIFO components. These components can be used in more complex client applications, as illustrated in [Figures 2](#) and [3](#). To use the FIFOs, the component_name_locallink component can be instantiated in the user design.

Receive Client FIFO

The Receive (Rx) Client FIFO, a 4k-byte FIFO implemented in block RAMS, can be used for more complex client applications and can be connected directly to the Rx Client Interface of the Ethernet MAC. The Rx Client provides a LocalLink connection for the user.

- The FIFO operates at all Ethernet speeds supported by the Ethernet MAC.
- The FIFO drops all frames marked as bad from the Ethernet MAC so that only error-free frames are passed to the Ethernet client.

Transmit Client FIFO

The Transmit (Tx) Client FIFO, a 4k-byte FIFO implemented in block RAMS, can be used for more complex client applications and can be connected directly to the Tx Client Interface of the Ethernet MAC. The Tx Client FIFO provides a LocalLink connection for the user.

- The FIFO operates at all Ethernet speeds supported by the Ethernet MAC.
- The FIFO is capable of half-duplex re-transmission. For this reason, if a collision occurs on the medium, the Ethernet MAC indicates a collision on the Tx Client interface and the FIFO automatically re-queues the frame for re-transmission.

Ethernet MAC Wrapper

The Ethernet MAC wrapper file instantiates the full Ethernet MAC primitive. For one or both Ethernet MACs (EMAC0/EMAC1), the following applies:

- All unused input ports on the primitive are tied to the appropriate logic level; all unused output ports are left unconnected.
- The Ethernet MAC attributes are set based on options selected in the CORE Generator.
- Only used ports are connected to the ports of the wrapper file.

This simplified wrapper should be used as the instantiation template for the Ethernet MAC in customer designs.

Physical I/F

An appropriate Physical Interface is provided for each selected EMAC0/EMAC1. This interface connects the physical interface of the Ethernet MAC block to the I/O of the FPGA. As required, the following components are provided:

- For GMII/MII, this component contains Input/Output block (IOB) buffers and IOB flip-flops.
- For RGMII, this component contains IOB buffers, IOB Double-Data Rate flip-flops and IODELAY elements to align the incoming data with the receiver clock. An IODELAY element is also used to delay the transmitted clock in RGMII V2.0.
- For 1000BASE-X PCS/PMA or SGMII, this component instantiates and connects a RocketIO GTP or GTX transceiver.

Device Utilization

The following sections provide approximate device-utilization figures for common configurations of the Ethernet MAC and its example design:

- **1 Gbps Only Operation**
- **Tri-Speed Operation**
- **100 Mbps or 10 Mbps Operation**

Of interest is the utilization of clock resources, specifically the global clock usage (BUFGs), which should influence the selection of the interface type. Note that these clock resource figures do not consider any clock that can be used for the Host Interface.

1 Gbps Only Operation

Table 1 defines approximate utilization figures for common configurations of the Ethernet MAC and its example design for 1 Gbps operation.

Table 1: Device Utilization for 1 Gbps Operation

Parameter Values		Device Resources				
Physical Interface	Ethernet MAC Usage	LUTs	Registers	18K Block RAMs	BUFGs	DCMs
GMII	Single EMAC	380	450	4	2 ¹	0
	Both EMACs	760	880	8	3 ¹	0
RGMII 1.3	Single EMAC	380	460	4	2 ¹	0
	Both EMACs	760	900	8	3 ¹	0
RGMII 2.0	Single EMAC	380	460	4	2 ¹	0
	Both EMACs	760	900	8	3 ¹	0
SGMII	Single EMAC	390	440	4	1	0
	Both EMACs	780	870	8	1	0
1000BASE-X (8-bit client)	Single EMAC	390	440	4	1	0
	Both EMACs	780	870	8	1	0
1000BASE-X (16-bit client)	Single EMAC	370	560	4	3	1
	Both EMACs	730	1120	8	3	1

1. These implementations use IDLEAY elements, which require a 200MHz reference clock for the associated IDELAYCTRL. The reference clock's BUFG is not accounted for.

Tri-Speed Operation

Table 2 defines approximate utilization figures for common configurations of the Ethernet MAC and its example design 10 Mbps, 100 Mbps, or 1 Gbps operation.

Table 2: Device Utilization for Tri-Speed Operation

Parameter Values		Device Resources				
Physical Interface	Ethernet MAC Usage	LUTs	Registers	18K Block RAMs	BUFGs	RCLKs
GMII/MII (standard clocking)	Single EMAC	380	450	4	5 ¹	0
	Both EMACs	760	890	8	10 ¹	0
GMII/MII (with clock enable)	Single EMAC	380	470	4	2 ¹	0
	Both EMACs	760	920	8	4 ¹	0
GMII/MII (with byte PHY)	Single EMAC	410	510	4	2 ¹	0
	Both EMACs	810	990	8	4 ¹	0
RGMII 1.3 (standard clocking)	Single EMAC	380	460	4	4 ¹	0
	Both EMACs	760	910	8	8 ¹	0
RGMII 1.3 (with clock enable)	Single EMAC	380	480	4	2 ¹	0
	Both EMACs	760	940	8	4 ¹	0
RGMII 2.0 (standard clocking)	Single EMAC	380	460	4	4 ¹	0
	Both EMACs	760	910	8	8 ¹	0
RGMII 2.0 (with clock enable)	Single EMAC	380	480	4	2 ¹	0
	Both EMACs	760	940	8	4 ¹	0
SGMII	Single EMAC	470	620	5	2	1
	Both EMACs	930	1220	10	3	2

1. These implementations use IDLEAY elements, which require a 200MHz reference clock for the associated IDELAYCTRL. The reference clock's BUFG is not accounted for.

100 Mbps or 10 Mbps Operation

Table 3 provides approximate utilization figures for common configurations of the Ethernet MAC and its example design for 10 Mbps or 100 Mbps operation. For all other interfaces, see [Tri-Speed Operation](#).

Table 3: Device Utilization for 10 Mbps, 100 Mbps Operation

Parameter Values		Device Resources			
Physical Interface	Ethernet MAC Usage	LUTs	Registers	18K Block RAMs	BUFGs
MII (standard clocking)	Single EMAC	380	440	4	4
	Both EMACs	760	880	8	8
MII (with clock enable)	Single EMAC	430	460	4	2
	Both EMACs	850	900	8	4
MII (with byte PHY)	Single EMAC	400	480	4	2
	Both EMACs	800	960	8	4

Ordering Information

The Ethernet MAC wrapper is provided under the [End User License Agreement](#) and can be generated using CORE Generator software v11.1 and higher. The CORE Generator software is shipped with Xilinx ISE Foundation™ Series Development software.

To access the wrapper, a no cost full license must be obtained from Xilinx. See the product page:

www.xilinx.com/products/ipcenter/V5_Embedded_TEMAC_Wrapper.htm

Contact your local Xilinx sales representative for pricing and availability of other Xilinx LogiCORE IP modules and software. Information on additional LogiCORE IP modules is available on the [Xilinx IP Center](#).

Revision History

Date	Version	Revision
10/23/06	1.0	Initial Xilinx release.
2/15/07	2.0	Core updated to version 1.2; Xilinx tools 9.1i.
8/8/05	2.2	Core updated to version 1.3; Xilinx tools 9.2, IUS v5.8.
3/24/08	3.0	Core updated to version 1.4; Xilinx tools 10.1; Virtex-5 FXT FPGA support.
9/19/08	4.0	Core updated to version 1.5; Virtex-5 TXT FPGA support.
4/24/09	5.0	Core updated to version 1.6 and Xilinx tools updated to version 11.1.

Notice of Disclaimer

Xilinx is providing this product documentation, hereinafter "Information," to you "AS IS" with no warranty of any kind, express or implied. Xilinx makes no representation that the Information, or any particular implementation thereof, is free from any claims of infringement. You are responsible for obtaining any rights you may require for any implementation based on the Information. All specifications are subject to change without notice. XILINX EXPRESSLY DISCLAIMS ANY WARRANTY WHATSOEVER WITH RESPECT TO THE ADEQUACY OF THE INFORMATION OR ANY IMPLEMENTATION BASED THEREON, INCLUDING BUT NOT LIMITED TO ANY

WARRANTIES OR REPRESENTATIONS THAT THIS IMPLEMENTATION IS FREE FROM CLAIMS OF INFRINGEMENT AND ANY IMPLIED WARRANTIES OF MERCHANTABILITY OR FITNESS FOR A PARTICULAR PURPOSE. Except as stated herein, none of the Information may be copied, reproduced, distributed, republished, downloaded, displayed, posted, or transmitted in any form or by any means including, but not limited to, electronic, mechanical, photocopying, recording, or otherwise, without the prior written consent of Xilinx.