

PlanAhead Software Tutorial

Debugging with ChipScope

UG 677 (v 12.2) July 23, 2010





Xilinx is disclosing this Document and Intellectual Property (hereinafter "the Design") to you for use in the development of designs to operate on, or interface with Xilinx FPGAs. Except as stated herein, none of the Design may be copied, reproduced, distributed, republished, downloaded, displayed, posted, or transmitted in any form or by any means including, but not limited to, electronic, mechanical, photocopying, recording, or otherwise, without the prior written consent of Xilinx. Any unauthorized use of the Design may violate copyright laws, trademark laws, the laws of privacy and publicity, and communications regulations and statutes.

Xilinx does not assume any liability arising out of the application or use of the Design; nor does Xilinx convey any license under its patents, copyrights, or any rights of others. You are responsible for obtaining any rights you may require for your use or implementation of the Design. Xilinx reserves the right to make changes, at any time, to the Design as deemed desirable in the sole discretion of Xilinx. Xilinx assumes no obligation to correct any errors contained herein or to advise you of any correction if such be made. Xilinx will not assume any liability for the accuracy or correctness of any engineering or technical support or assistance provided to you in connection with the Design.

THE DESIGN IS PROVIDED "AS IS" WITH ALL FAULTS, AND THE ENTIRE RISK AS TO ITS FUNCTION AND IMPLEMENTATION IS WITH YOU. YOU ACKNOWLEDGE AND AGREE THAT YOU HAVE NOT RELIED ON ANY ORAL OR WRITTEN INFORMATION OR ADVICE, WHETHER GIVEN BY XILINX, OR ITS AGENTS OR EMPLOYEES. XILINX MAKES NO OTHER WARRANTIES, WHETHER EXPRESS, IMPLIED, OR STATUTORY, REGARDING THE DESIGN, INCLUDING ANY WARRANTIES OF MERCHANTABILITY, FITNESS FOR A PARTICULAR PURPOSE, TITLE, AND NONINFRINGEMENT OF THIRD-PARTY RIGHTS.

IN NO EVENT WILL XILINX BE LIABLE FOR ANY CONSEQUENTIAL, INDIRECT, EXEMPLARY, SPECIAL, OR INCIDENTAL DAMAGES, INCLUDING ANY LOST DATA AND LOST PROFITS, ARISING FROM OR RELATING TO YOUR USE OF THE DESIGN, EVEN IF YOU HAVE BEEN ADVISED OF THE POSSIBILITY OF SUCH DAMAGES. THE TOTAL CUMULATIVE LIABILITY OF XILINX IN CONNECTION WITH YOUR USE OF THE DESIGN, WHETHER IN CONTRACT OR TORT OR OTHERWISE, WILL IN NO EVENT EXCEED THE AMOUNT OF FEES PAID BY YOU TO XILINX HEREUNDER FOR USE OF THE DESIGN. YOU ACKNOWLEDGE THAT THE FEES, IF ANY, REFLECT THE ALLOCATION OF RISK SET FORTH IN THIS AGREEMENT AND THAT XILINX WOULD NOT MAKE AVAILABLE THE DESIGN TO YOU WITHOUT THESE LIMITATIONS OF LIABILITY.

The Design is not designed or intended for use in the development of on-line control equipment in hazardous environments requiring fail-safe controls, such as in the operation of nuclear facilities, aircraft navigation or communications systems, air traffic control, life support, or weapons systems ("High-Risk Applications") Xilinx specifically disclaims any express or implied warranties of fitness for such High-Risk Applications. You represent that use of the Design in such High-Risk Applications is fully at your risk.

© 2010 Xilinx, Inc. All rights reserved. XILINX, the Xilinx logo, and other designated brands included herein are trademarks of Xilinx, Inc. All other trademarks are the property of their respective owners.

Demo Design License

© 2010 Xilinx, Inc.

This Design is free software; you can redistribute it and/or modify it under the terms of the GNU Lesser General Public License as published by the Free Software Foundation; either version 2.1 of the License, or (at your option) any later version.

This library is distributed in the hope that it will be useful, but WITHOUT ANY WARRANTY; without even the implied warranty of MERCHANTABILITY or FITNESS FOR A PARTICULAR PURPOSE. See the GNU Lesser General Public License for more details.

You should have received a copy of the GNU Library General Public License along with this design file; if not, see: <http://www.gnu.org/licenses/>



The PlanAhead™ software source code includes the source code for the following programs:

Centerpoint XML

- The initial developer of the original code is CenterPoint – Connective Software
- Software Engineering GmbH. portions created by CenterPoint – Connective Software
- Software Engineering GmbH. are Copyright© 1998-2000 CenterPoint - Connective Software Engineering GmbH. All Rights Reserved. Source code for CenterPoint is available at <http://www.cpointc.com/XML/>

NLView Schematic Engine

- Copyright© Concept Engineering.

Static Timing Engine by Parallax Software Inc.

- Copyright© Parallax Software Inc.

Java Two Standard Edition

- Includes portions of software from RSA Security, Inc. and some portions licensed from IBM are available at <http://oss.software.ibm.com/icu4j/>
- Powered By JIDE – <http://www.jidesoft.com>

The BSD License for the JGoodies Looks

Copyright© 2001-2010 JGoodies Karsten Lentzsch. All rights reserved.

Redistribution and use in source and binary forms, with or without modification, are permitted provided that the following conditions are met:

- Redistributions of source code must retain the above copyright notice, this list of conditions and the following disclaimer.
- Redistributions in binary form must reproduce the above copyright notice, this list of conditions and the following disclaimer in the documentation and/or other materials provided with the distribution.
- Neither the name of JGoodies Karsten Lentzsch nor the names of its contributors may be used to endorse or promote products derived from this software without specific prior written permission.

THIS SOFTWARE IS PROVIDED BY THE COPYRIGHT HOLDERS AND CONTRIBUTORS "AS IS" AND ANY EXPRESS OR IMPLIED WARRANTIES, INCLUDING, BUT NOT LIMITED TO, THE IMPLIED WARRANTIES OF MERCHANTABILITY AND FITNESS FOR A PARTICULAR PURPOSE ARE DISCLAIMED. IN NO EVENT SHALL THE COPYRIGHT OWNER OR CONTRIBUTORS BE LIABLE FOR ANY DIRECT, INDIRECT, INCIDENTAL, SPECIAL, EXEMPLARY, OR CONSEQUENTIAL DAMAGES (INCLUDING, BUT NOT LIMITED TO, PROCUREMENT OF SUBSTITUTE GOODS OR SERVICES; LOSS OF USE, DATA, OR PROFITS; OR BUSINESS INTERRUPTION) HOWEVER CAUSED AND ON ANY THEORY OF LIABILITY, WHETHER IN CONTRACT, STRICT LIABILITY, OR TORT (INCLUDING NEGLIGENCE OR OTHERWISE) ARISING IN ANY WAY OUT OF THE USE OF THIS SOFTWARE, EVEN IF ADVISED OF THE POSSIBILITY OF SUCH DAMAGE



Free IP Core License

This is the Entire License for all of our Free IP Cores.

Copyright (C) 2000-2003, ASICs World Services, LTD. AUTHORS

All rights reserved.

Redistribution and use in source, netlist, binary and silicon forms, with or without modification, are permitted provided that the following conditions are met:

Redistributions of source code must retain the above copyright notice, this list of conditions and the following disclaimer.

Redistributions in binary form must reproduce the above copyright notice, this list of conditions and the following disclaimer in the documentation and/or other materials provided with the distribution.

Neither the name of ASICs World Services, the Authors and/or the names of its contributors may be used to endorse or promote products derived from this software without specific prior written permission.

THIS SOFTWARE IS PROVIDED BY THE COPYRIGHT HOLDERS AND CONTRIBUTORS "AS IS" AND ANY EXPRESS OR IMPLIED WARRANTIES, INCLUDING, BUT NOT LIMITED TO, THE IMPLIED WARRANTIES OF MERCHANTABILITY AND FITNESS FOR A PARTICULAR PURPOSE ARE DISCLAIMED. IN NO EVENT SHALL THE COPYRIGHT OWNER OR CONTRIBUTORS BE LIABLE FOR ANY DIRECT, INDIRECT, INCIDENTAL, SPECIAL, EXEMPLARY, OR CONSEQUENTIAL DAMAGES (INCLUDING, BUT NOT LIMITED TO, PROCUREMENT OF SUBSTITUTE GOODS OR SERVICES; LOSS OF USE, DATA, OR PROFITS; OR BUSINESS INTERRUPTION) HOWEVER CAUSED AND ON ANY THEORY OF LIABILITY, WHETHER IN CONTRACT, STRICT LIABILITY, OR TORT (INCLUDING NEGLIGENCE OR OTHERWISE) ARISING IN ANY WAY OUT OF THE USE OF THIS SOFTWARE, EVEN IF ADVISED OF THE POSSIBILITY OF SUCH DAMAGE.

Table of Contents

Debugging with ChipScope.....	7
Introduction	7
Sample Design Data	7
Xilinx ISE Design Suite and PlanAhead Software	8
Required Hardware	8
PlanAhead Documentation and Information	8
Tutorial Description	8
Tutorial Objectives	9
Tutorial Steps	9
Step 1: Open a Project Step 1.....	10
Step 2: Run the Set Up ChipScope Wizard Step 2.....	12
Step 3: Add Additional Debug Nets Step 3	18
Step 4: Change Debug Core Attributes Step 4	21
Step 5: Implement ChipScope Debug Cores Step 5.....	23
Step 6: Implement the Design Step 6.....	27
Step 7: Generate a Bitstream - Launch ChipScope Analyzer Step 7	28
Conclusion	29

PlanAhead Software Tutorial

Debugging with ChipScope

Introduction

This tutorial:

- Shows you how to use the Xilinx® PlanAhead™ software to debug designs using the ChipScope™ debugging tool.
- Provides a quick walk through using PlanAhead to insert ChipScope debug cores into your designs.
- Guides you through the selection of nets for debug, and automates the generation of debug cores, instantiation, connectivity, and synthesis operations with the CORE Generator™ tool.
- Shows you how to implement a design with ChipScope cores, import placement and timing reports, run BitGen, and launch ChipScope Analyzer.
- Has been validated with ISE® Design Suite Release 12.1. Be sure that your installation is set to this revision or newer before beginning.
- Covers only a subset of the features contained in the PlanAhead software bundled with ISE Design Suite Release 12.1.

Other tutorials cover many other PlanAhead features in detail, and not every command or command option is covered. The tutorial uses the features contained in the PlanAhead software product, which is bundled as a part of the ISE Design Suite. If you have any questions or comments about this tutorial, contact Xilinx Technical Support.

Sample Design Data

This tutorial uses sample design data included with the PlanAhead software. The design data is located in the following directory:

```
<ISE_install_Dir>/PlanAhead/testcases/PlanAhead_Tutorial.zip
```

Save and extract the zip file into any write-accessible location. The location of the unzipped PlanAhead_Tutorial data is referred to as the <Install_Dir> throughout this document.

The tutorial sample design data is modified while performing this tutorial. A new copy of the original PlanAhead_Tutorial data is required each time you run the tutorial. For more information about the example design, see the *Tutorial Description* section.

Xilinx ISE Design Suite and PlanAhead Software

PlanAhead software is installed with ISE Design Suite by default. Before beginning this tutorial, ensure that PlanAhead is operational, and that the sample design data has been installed. For installation instructions and information, see the *ISE Design Suite 12: Installation, Licensing, and Release Notes* on the Xilinx website:

http://www.xilinx.com/support/documentation/sw_manuals/xilinx12_2/irn.pdf

Required Hardware

Xilinx recommends 2 GB or more of RAM for use with PlanAhead on larger devices. For this tutorial, a smaller design was used, with a limited number of designs open at any one time. 1 GB of RAM should be sufficient, but it could impact performance.

PlanAhead Documentation and Information

For information about the PlanAhead software, see the following documents, which are available with your software:

- *PlanAhead User Guide* (UG632) - Provides detailed information about the PlanAhead software. http://www.xilinx.com/support/documentation/sw_manuals/xilinx12_2/PlanAhead_UserGuide.pdf
- *Floorplanning Methodology Guide* (UG633) - Provides floorplanning hints. http://www.xilinx.com/support/documentation/sw_manuals/xilinx12_2/Floorplanning_Methodology_Guide.pdf
- *Hierarchical Design Methodology Guide* (UG748) - Provides an overview of the PlanAhead hierarchical design capabilities. http://www.xilinx.com/support/documentation/sw_manuals/xilinx12_2/Hierarchical_Design_Methodology_Guide.pdf
- For additional information about PlanAhead, including video demonstrations, go to <http://www.xilinx.com/planahead>.

Tutorial Description

The sample design used in this tutorial consists of a typical system on a chip design with a RISC CPU core connected to several peripheral cores using a Wishbone bus arbiter. There are Verilog and VHDL source files.

The design targets an xc6vlx75Tff784 device. This tutorial uses a project file that has already synthesized the HDL and is ready to be implemented.

The tutorial design data is modified during the course of this tutorial. Xilinx recommends that you use a new copy of the original PlanAhead_Tutorial data each time the tutorial is performed. For more information on the tutorial data, see the *Sample Design Data* section above.

If you have any questions or comments about the tutorial, contact Xilinx Technical Support.

Tutorial Objectives

After completing this tutorial, you will have:

- Inserted ChipScope debug cores into designs using the Set Up ChipScope wizard
- Added additional debug nets and re-created ChipScope debug cores
- Changed default options on ChipScope debug cores
- Implemented ChipScope debug cores
- Implemented designs with ChipScope debug cores in the PlanAhead software

Tutorial Steps

This tutorial is separated into steps, followed by general instructions and supplementary detailed steps allowing you to make choices based on your skill level as you progress through the tutorial.

If you need help completing a general instruction, go to the detailed steps below it, or if you are ready, simply skip the step-by-step directions and move on to the next general instruction.

This tutorial has seven primary steps:

Step 1: Open a project

Step 2: Run the Set up ChipScope Wizard

Step 3: Add Additional Debug Nets

Step 4: Change Debug Core Attributes.

Step 5 Implement ChipScope Debug Cores

Step 6: Implement the Design

Step 7: Generate a Bitstream - Launch ChipScope Analyzer (optional)

Step 1: Open a Project

Step 1

PlanAhead enables several types of projects to be created depending on the location in the design flow where the software is being used. RTL sources or synthesized netlists can be used to create a Project for development, analysis, or to take all the way through implementation and bit file creation. This tutorial uses a synthesized netlist project which has not yet implemented.

1-1. Open the software.

1-1-1. On Windows, double-click the Xilinx PlanAhead 12.2 desktop icon, or select **Start > Programs > Xilinx ISE Design Suite 12.2 > PlanAhead > PlanAhead**.

1-1-2. On Linux, change the directory to
<Install_Dir>/PlanAhead_Tutorial/Tutorial_Created_Data, and type **planAhead**.

The PlanAhead Getting Started Help page opens.

1-2. Open the example project_cpu_netlist Project.

The example design Project netlist is modified during this tutorial. You will open the example design and then save the project to a different name so the original example design project can be re-used.

1-2-1. In the Getting Started page, select **Open Example Design > CPU (Synthesized)**.

1-2-2. Select **File > Save Project As** to save the project with a different project name.

The **Save Project As** dialog box opens.

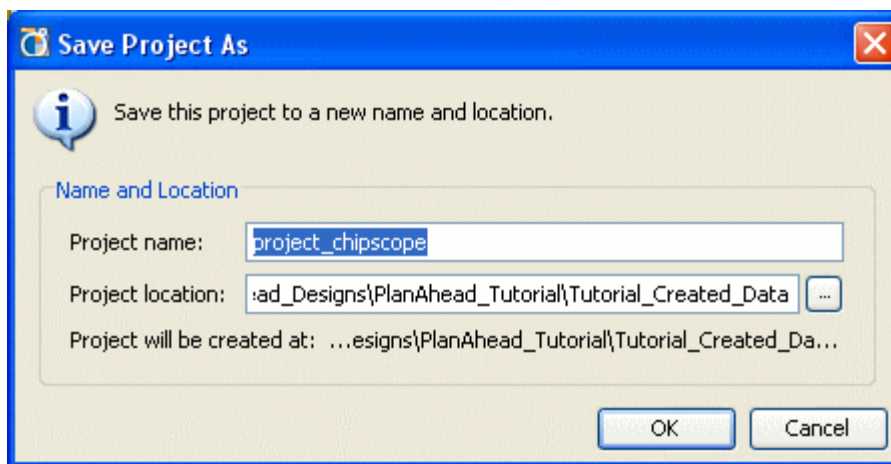

Figure 1: Saving the Project

1-2-3. In the **Project Name** text box, type a unique name for the project, such as **project_chipscope**.

1-2-4. Enter the following new Project location:

<Install_Dir>/PlanAhead_Tutorial/Tutorial_Created_Data/

1-2-5. Click **OK**.

The Project Manager opens with the design sources displayed in the Sources view.

- 1-2-6.** In the Flow Navigator on the left side of the PlanAhead environment, select **Netlist Design**. The Netlist Design is now open and ready to insert debug logic. See the following Figure 2.

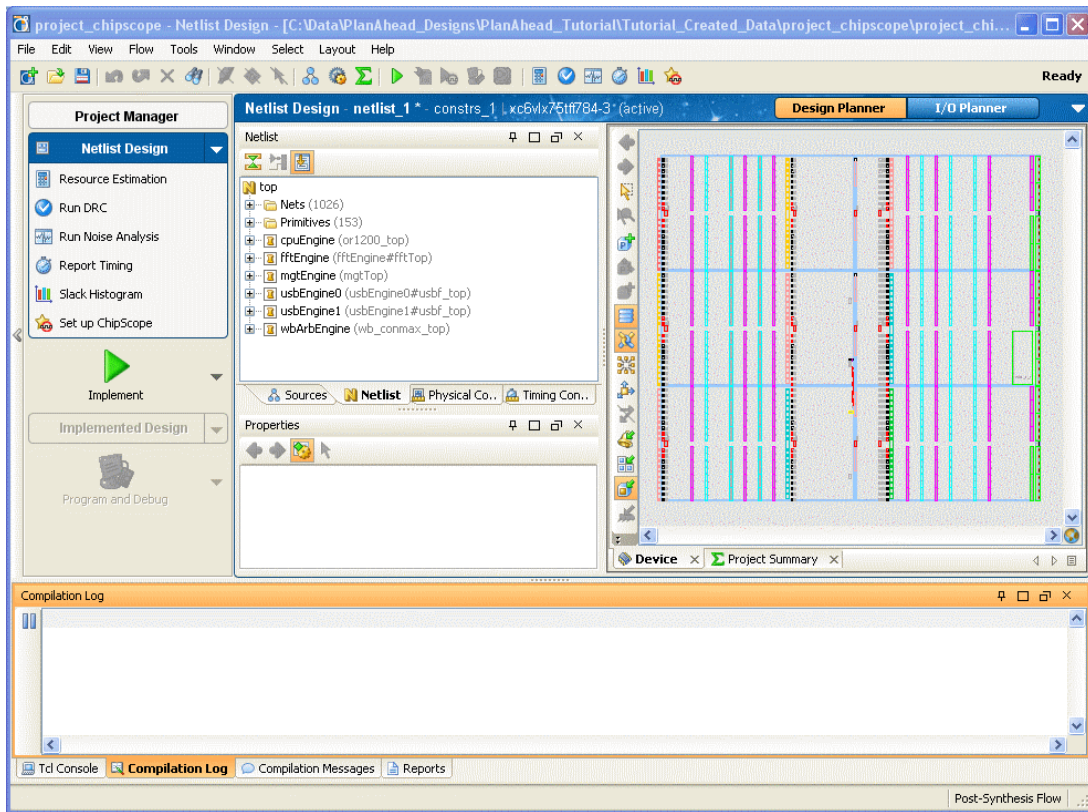

Figure 2: The Project in the Netlist Design Environment

Step 2: Run the Set Up ChipScope Wizard

Step 2

Use the ChipScope debug core insertion flow to configure and instantiate the Integrated CONTroller (ICON) and Integrated Logic Analyze (ILA) cores into a synthesized netlist project.

You can use the Set Up ChipScope wizard to:

- Select nets for debugging
- Determine how many cores are needed
- Instantiate and connect the core trigger ports to these nets

2-1. Select the **wbArbEngine/m0/wb*** nets to connect to ChipScope cores.

2-1-1. In the Flow Navigator menu, select **Set Up ChipScope**.

The Set up ChipScope wizard opens.

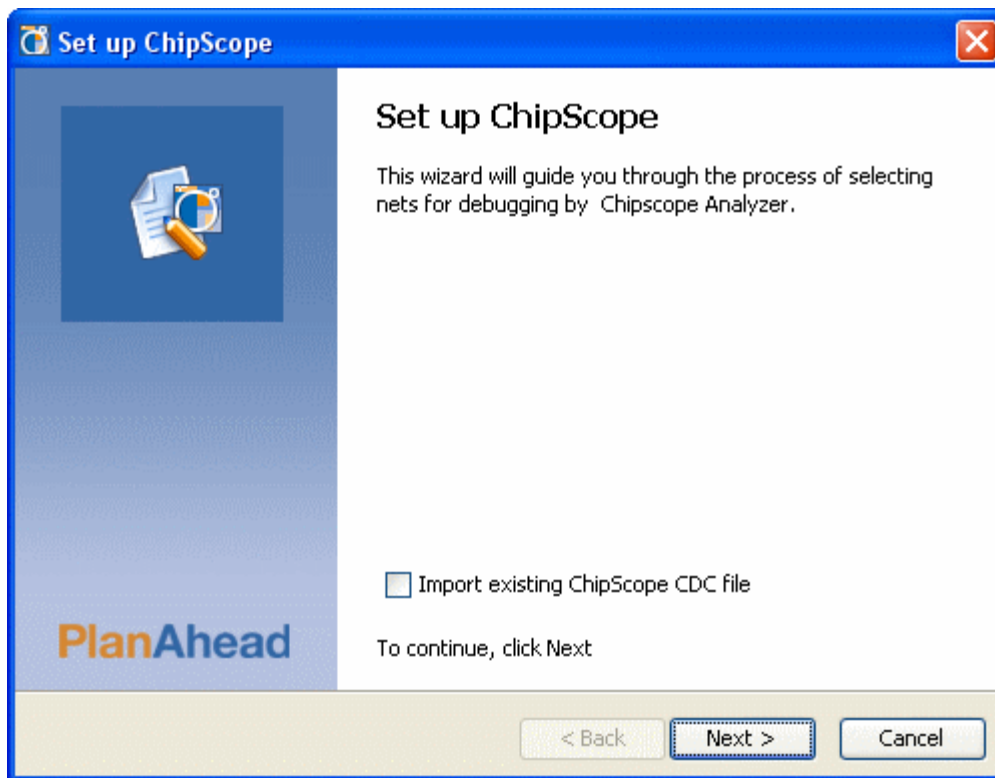

Figure 3: Set Up ChipScope

2-1-2. Click Next.

The Specify Nets to Debug page displays.

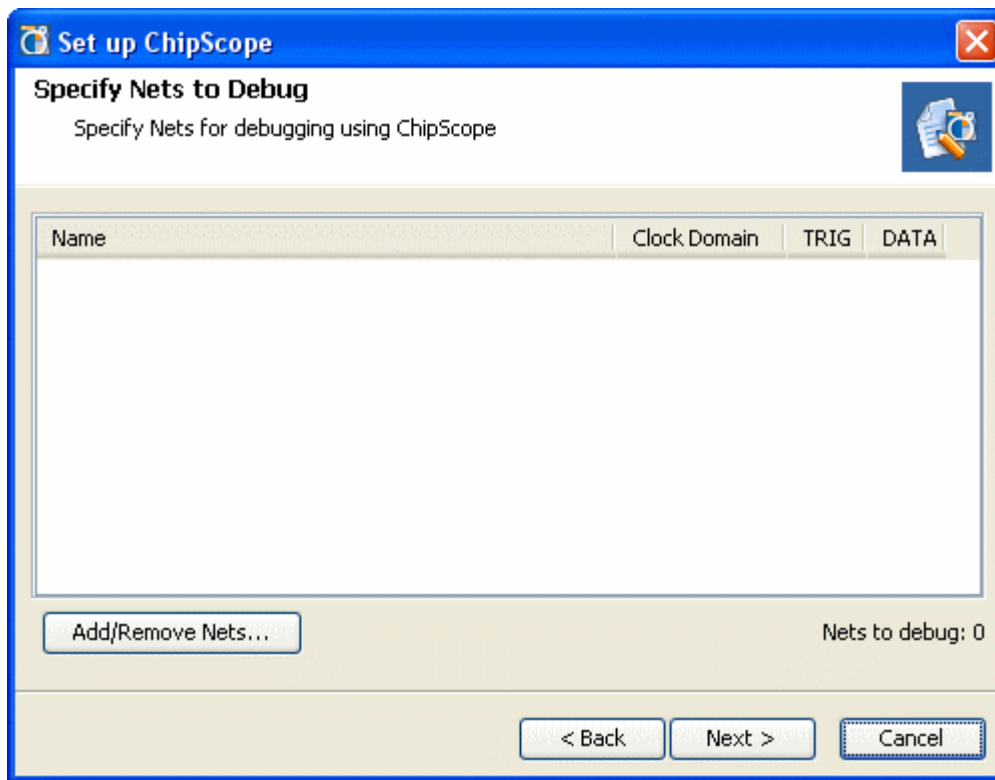

Figure 4: Specify Nets to Debug Page

2-1-3. Click Add/Remove Nets.

The Add/Remove Nets dialog box opens (Figure 5).

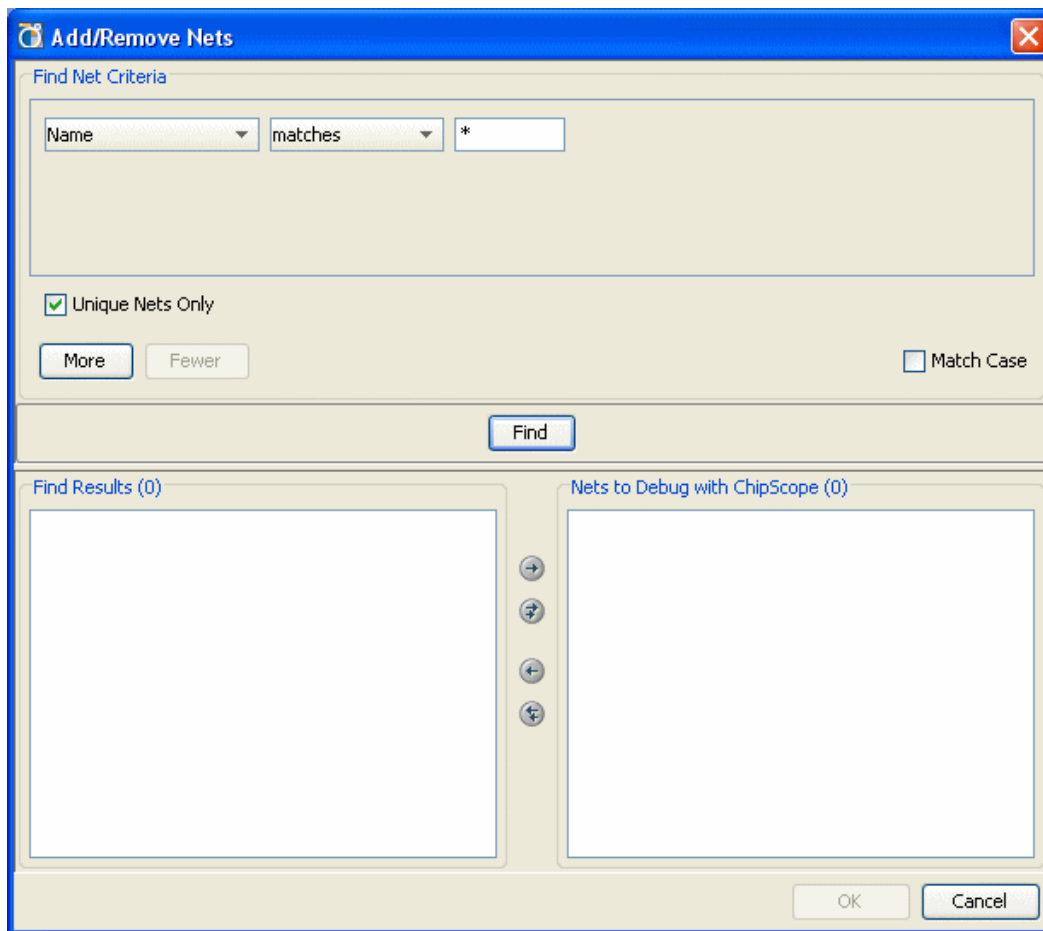

Figure 5: Add/Remove Nets Dialog Box

2-1-4. In the Find Net Criteria Matches text box, type **wbArbEngine/m0/wb_***.

2-1-5. Click **Find**.

The Add/Remove Nets dialog box opens with the Find Results box populated (Figure 6).

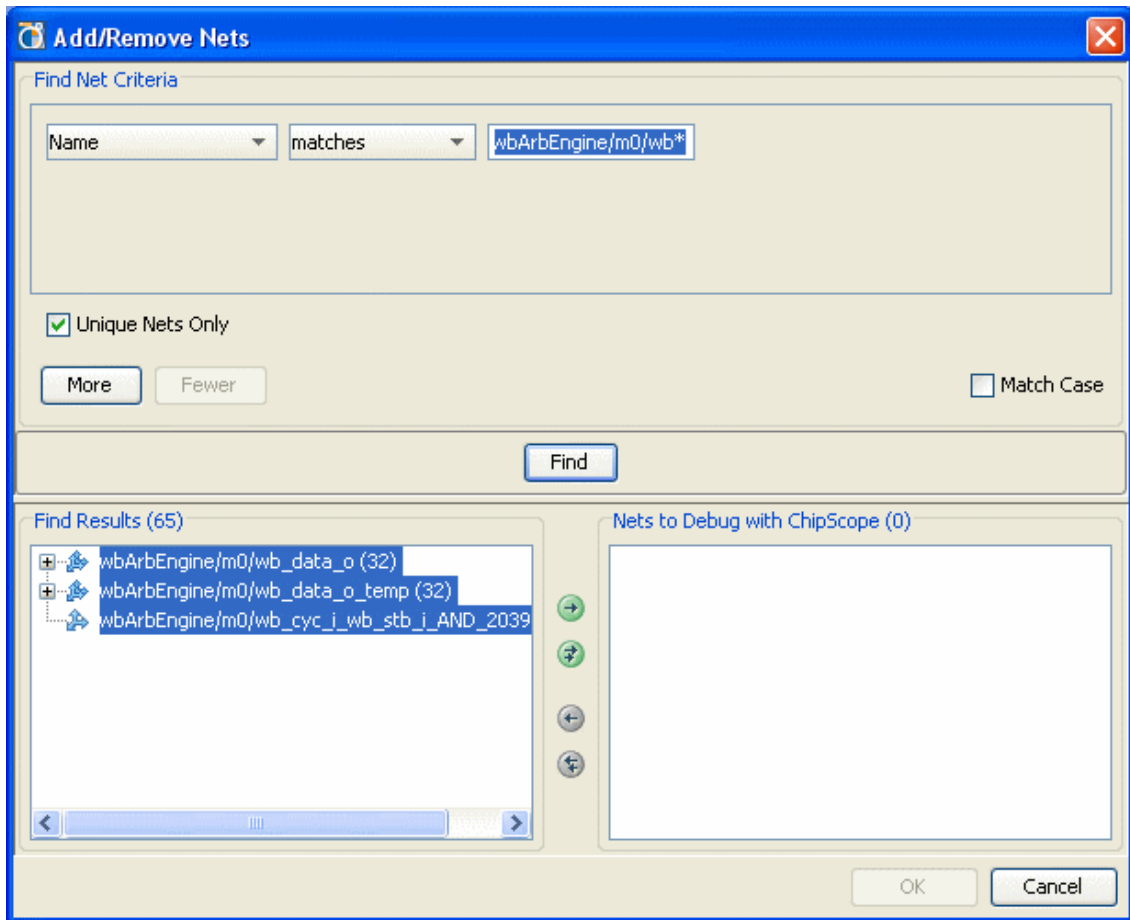



Figure 6: Add/Remove Nets Dialog Box with Find Results Populated

- 2-1-6.** Click the Move all Nets to the Right  button to add all nets to the Nets to Debug with ChipScope list.

The Add/Remove Nets dialog box now has the Nets to Debug with ChipScope list populated.

- 2-1-7.** Click **OK**.

The Specify Nets to Debug pane of the Set Up ChipScope wizard opens (Figure 7).

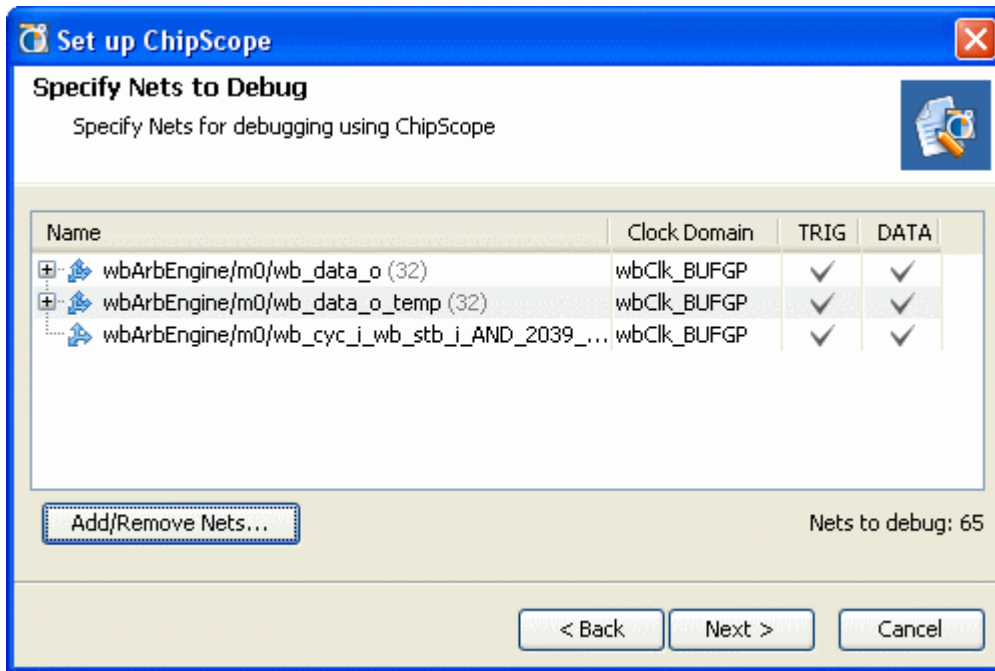

Figure 7: Set Up ChipScope Wizard with Nets to Debug Specified

Notice that the nets are all on the same Clock Domain, so only one ILA core should be required.

2-1-8. Click **Next**.

The Summary page displays.



Figure 8: ChipScope Summary Page

2-1-9. Click **Finish**.

This returns you to the Netlist Design environment, with the ChipScope view displayed.

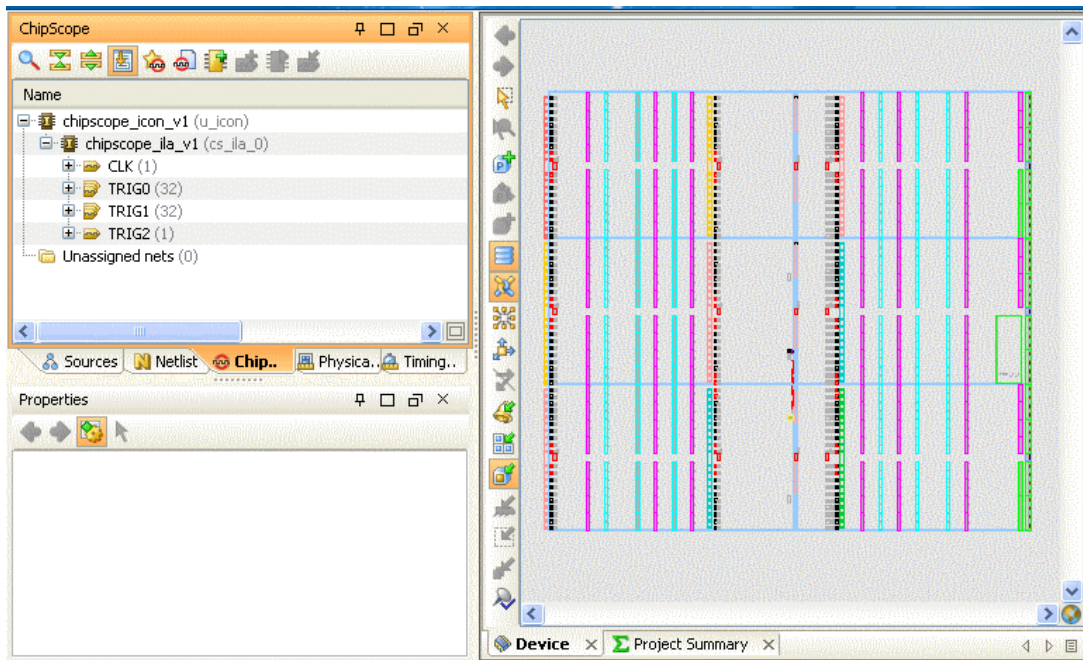

Figure 9: PlanAhead Environment with ChipScope Cores Inserted

The ChipScope view contains information about the generated cores as well as any Unassigned Nets. Core configuration and management is performed in this view. You use this view in some of the later steps of this tutorial.

2-2. View the ILA and ICON debug cores in the Netlist view.

2-2-1. Select the Netlist tab.

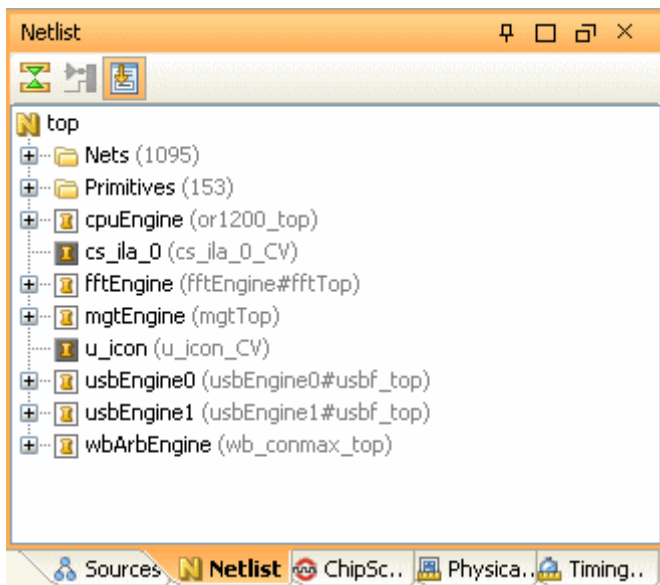



Figure 10: Debug Core Black Box Instance in Netlist Design



The `u_icon` and `cs_ila_0` are new instances inserted into the netlist. Both are marked with black box  icons in the Netlist view.

Step 3: Add Additional Debug Nets

Step 3

You have now added a set of nets connected to ChipScope debug cores and are ready to implement your design. This portion of the tutorial demonstrates alternate methods to add additional nets to be debugged and re-generate the cores. If you were satisfied with the list of nets already being debugged, this step is not necessary.

3-1. Use the Set Up ChipScope wizard to re-configure the Debug cores.

- 3-1-1.** Click the  icon next to the `cpuEngine` hierarchy in the **Netlist** view to expand the hierarchy below the CPU module.
- 3-1-2.** Click the  icon next to the `iwb_biu` hierarchy below the `cpuEngine` module to expand the hierarchy below the wishbone bus for the instruction fetch module of the CPU.
- 3-1-3.** Click the  icon next to the `/Nets` folder under the `iwb_biu` hierarchy to expand the list of nets within the wishbone interface.
- 3-1-4.** Select the `wb_adr_o` bus under the `/Nets` folder to select all 32 bits of the wishbone address output vector.

The Netlist view of the PlanAhead environment should look like it does in Figure 11 below.

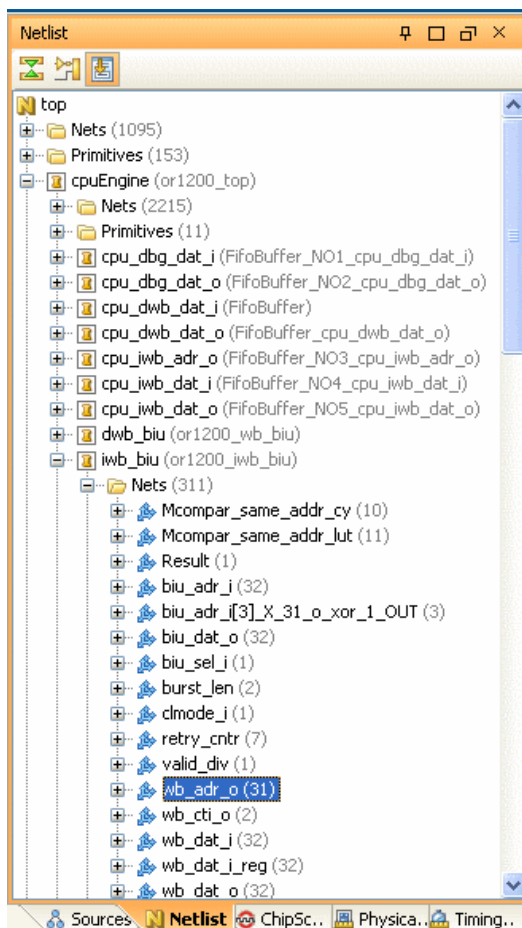

Figure 11: Netlist View with `wb_adr_o` Bus Selected

3-1-5. In the Flow Navigator, click **Set up ChipScope** to restart the Set Up ChipScope wizard.

The Set up ChipScope wizard opens.

3-1-6. Click **Next**.

The Existing Debug Nets page displays.

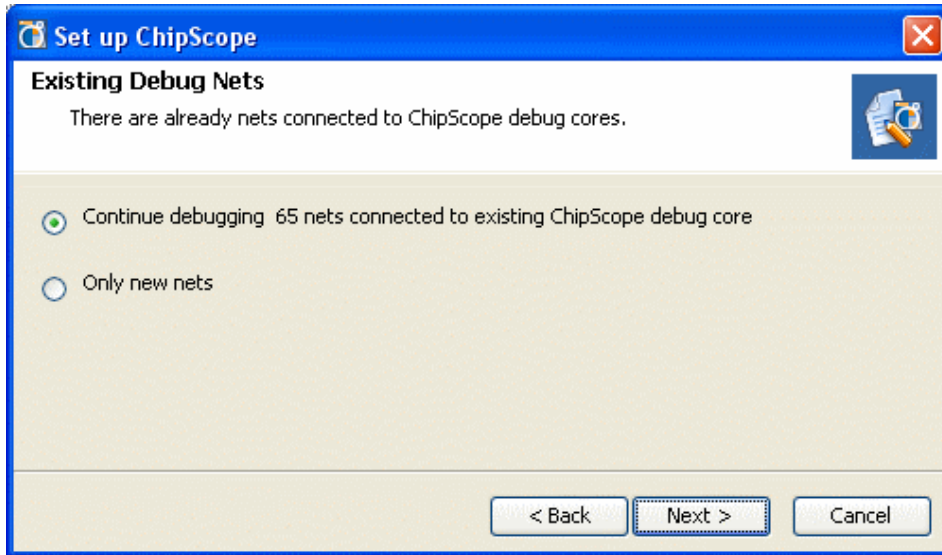

Figure 12: Existing Debug Nets Page of the Set Up ChipScope Wizard

3-1-7. Click **Next** to reconfigure the cores attached to the previous debug nets along with the new nets.

The Specify Nets to Debug page displays, showing an additional 32 nets to debug.

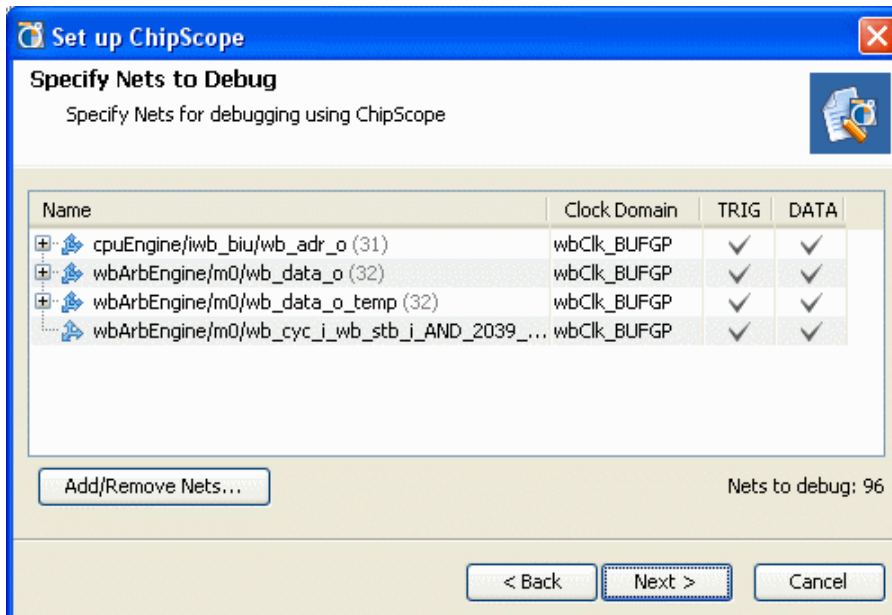

Figure 13: Specify Nets to Debug Page of the Set Up ChipScope Wizard

Notice again that the Clock Domain signals are all `wbClk_BUFGP`.

- 3-1-8.** Click **Next** to accept the list of debug nets.

The Existing ChipScope Cores page displays, prompting you to remove the previous debug cores and create a new set.

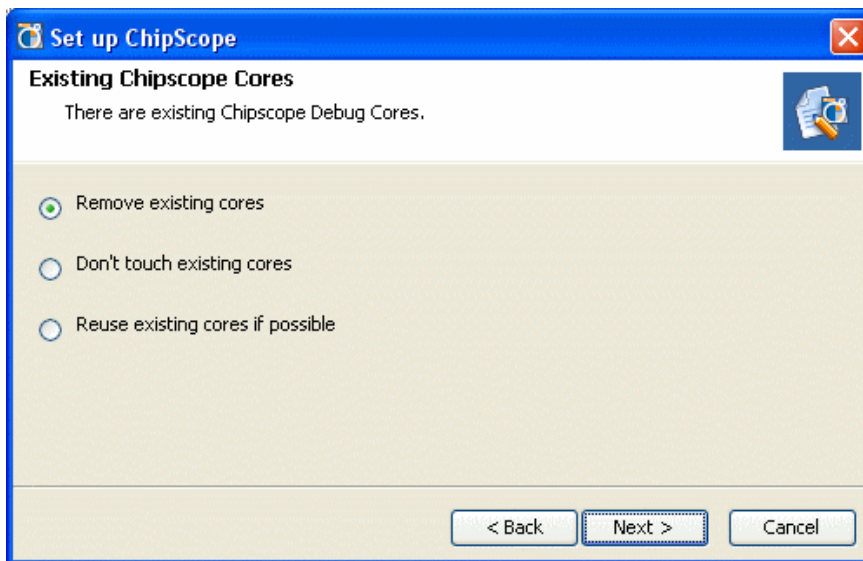

Figure 14: Existing ChipScope Cores Page of the Set Up ChipScope Wizard

- 3-1-9.** Click **Next** to remove the existing cores and create a new set based on the new list of nets and clock domains.

The Summary page displays.

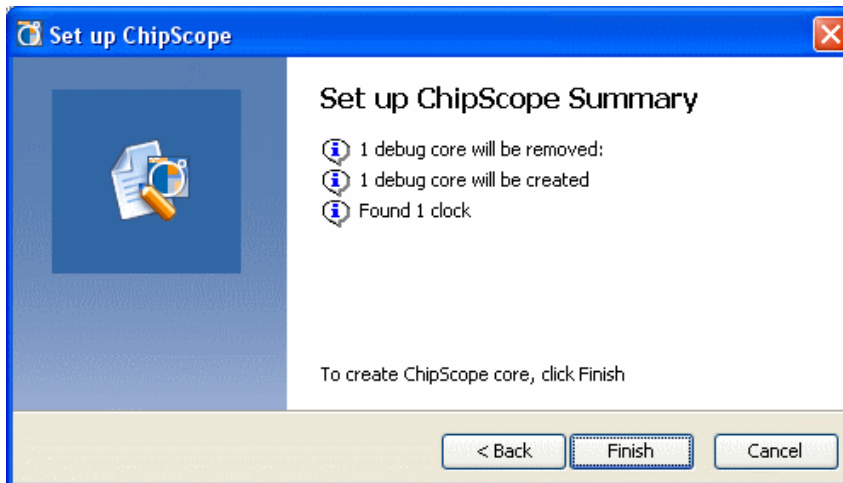

Figure 15: Summary Page of the Set Up ChipScope Wizard

- 3-1-10.** Click **Finish** to remove the previously defined core and create the new one.

Step 4: Change Debug Core Attributes

Step 4

Now you change the default attributes for the ChipScope ILA cores.

4-1. Change the `csdebugcore_1_0` trigger port TRIG0 port property `match_type`.

- 4-1-1. Select the ChipScope view tab to bring it to the front of the screen.
- 4-1-2. Select the `chipscope_ila_v1` instance.
- 4-1-3. Click the TRIG0 debug port of `chipscope_ila_v1`.
- 4-1-4. In the Debug Port Properties view, click the Options tab.
- 4-1-5. In the Debug Port Properties view, click in the right column next to `match_type` to view a drop down list of the options.
- 4-1-6. Select **extended_with_edges** to change the trigger port match type.

The Debug Port Properties view is displayed.

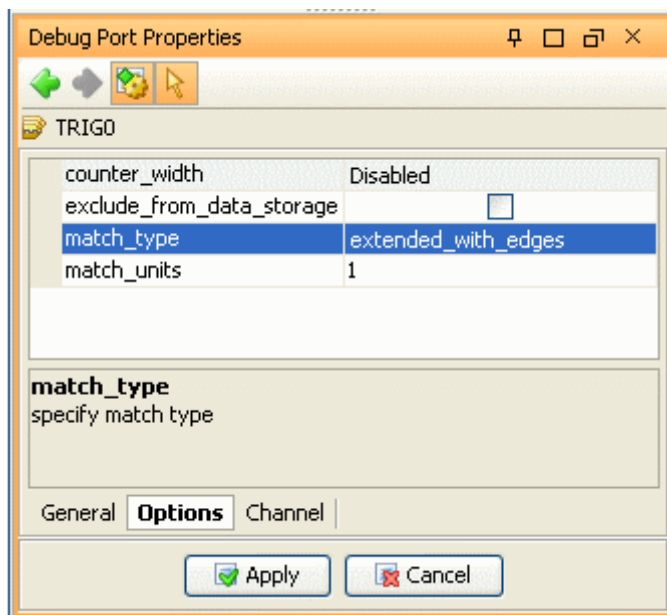

Figure 16: Debug Port Properties View with `match_type` Set

- 4-1-7. Click **Apply** to accept the change.

4-2. Change the data sampling depth.

You can change the data sampling depth from the default depth of 1024 to 2048 to take advantage of additional block RAM capacity in the design as follows:

4-2-1. In the ChipScope view, click **chipscope_ila_v1**.

4-2-2. In the Debug Core Properties view, click **sample_data_depth**.

4-2-3. Click the right column next to `sample_data_depth` and select **2048** from the drop down list.

The Debug Core Properties view opens.

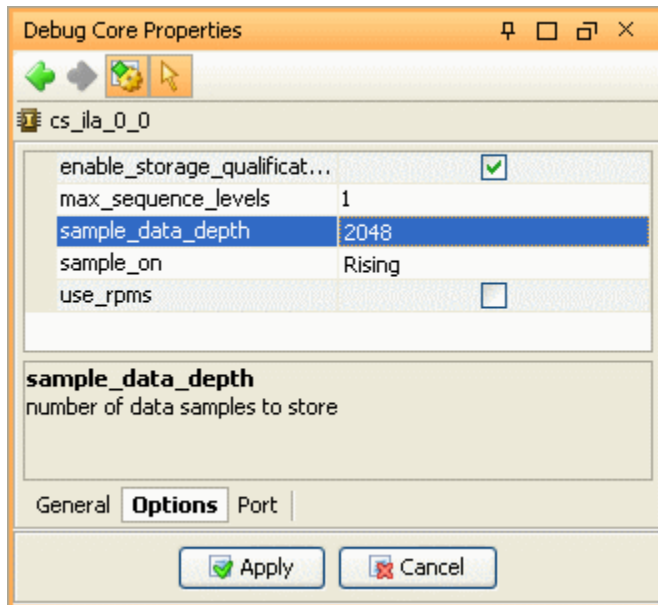

Figure 17: Debug Core Properties with `sample_data_depth` set to 2048

4-2-4. Click **Apply** to confirm the property change.

Step 5: Implement ChipScope Debug Cores

Step 5

You have now inserted black box models for the ChipScope debug cores connected to the debug nets you selected. When you implement the FPGA design using Run Implementation, the PlanAhead software converts these black box debug cores automatically to synthesized cores by calling the CORE Generator software prior to implementing with NGDBuild, Map, and PAR.

However, if you want to floorplan the debug cores along with any critical logic you might be debugging, you must first implement them.

5-1. Implement the ChipScope debug cores.

5-1-1. Click the ChipScope view tab to ensure that it is the active view and select the **chipscope_ila_v1** core.

5-1-2. Click the Implement ChipScope Debug Cores  button.

5-1-3. Click **OK** to save the Project, if prompted.

This invokes CORE Generator and configures each of the ChipScope Debug cores created in the previous step. This might take a few minutes.

5-1-4. Select the Netlist view tab.

5-1-5. Click Collapse All. 

Since the cores are now implemented, the `u_icon` and `chipscope_ila_v1` instances in the Netlist view change from black boxes to cores.

5-1-6. Expand and select the **cs_ila_0_0** instance.

5-1-7. In the Instance Properties view, select the **Statistics** tab.

The Primitive Statistics displays the logic used to implement the core.

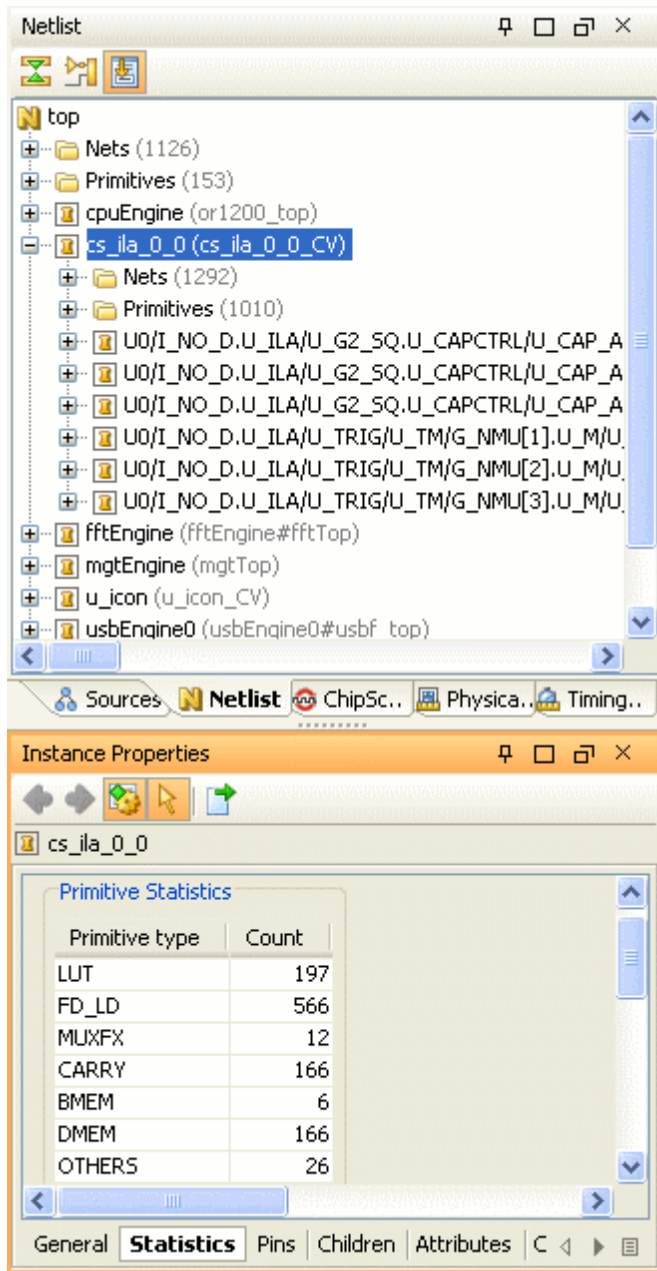



Figure 18: Displaying Debug Core Resource Usage

5-1-8. In the Netlist view, make sure the `cs_ila_0_0` instance is still selected.

5-1-9. In the Netlist view, click Schematic.  The schematic for the ILA core instantiation `cs_ila_0_0` opens.

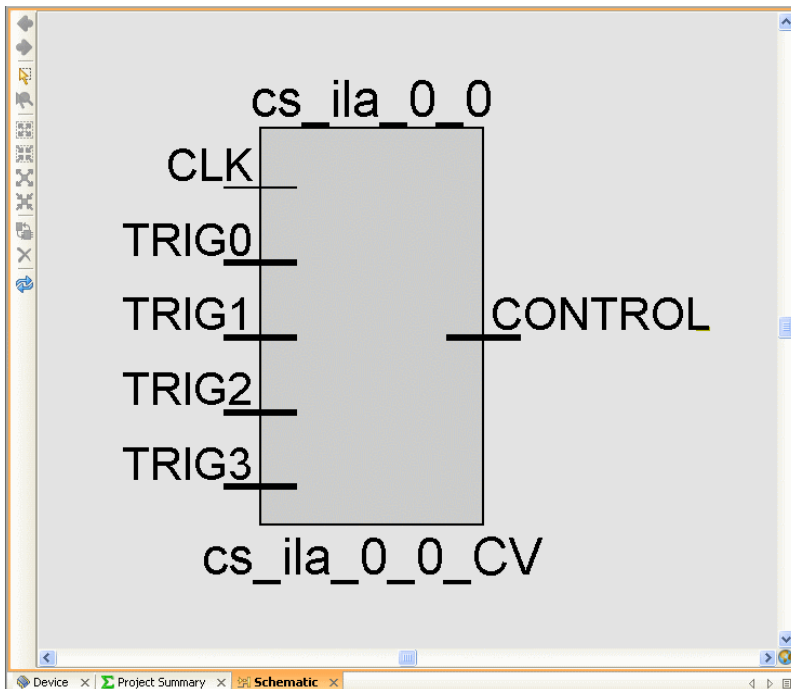



Figure 19: Schematic for the cs_ila_0_0 debug core

- 5-1-10.** Double-click the **CLK** pin and the **TRIG1** pins on the outer side of the instance to expand these nets in the schematic.
- 5-1-11.** In the Schematic window, click the Regenerate Schematic  button.
- 5-1-12.** Zoom in to view the expanded cs_ila_0_0 schematic (Figure 20). To Zoom in, click on the schematic diagram in the upper-left corner and drag the mouse to the lower right.

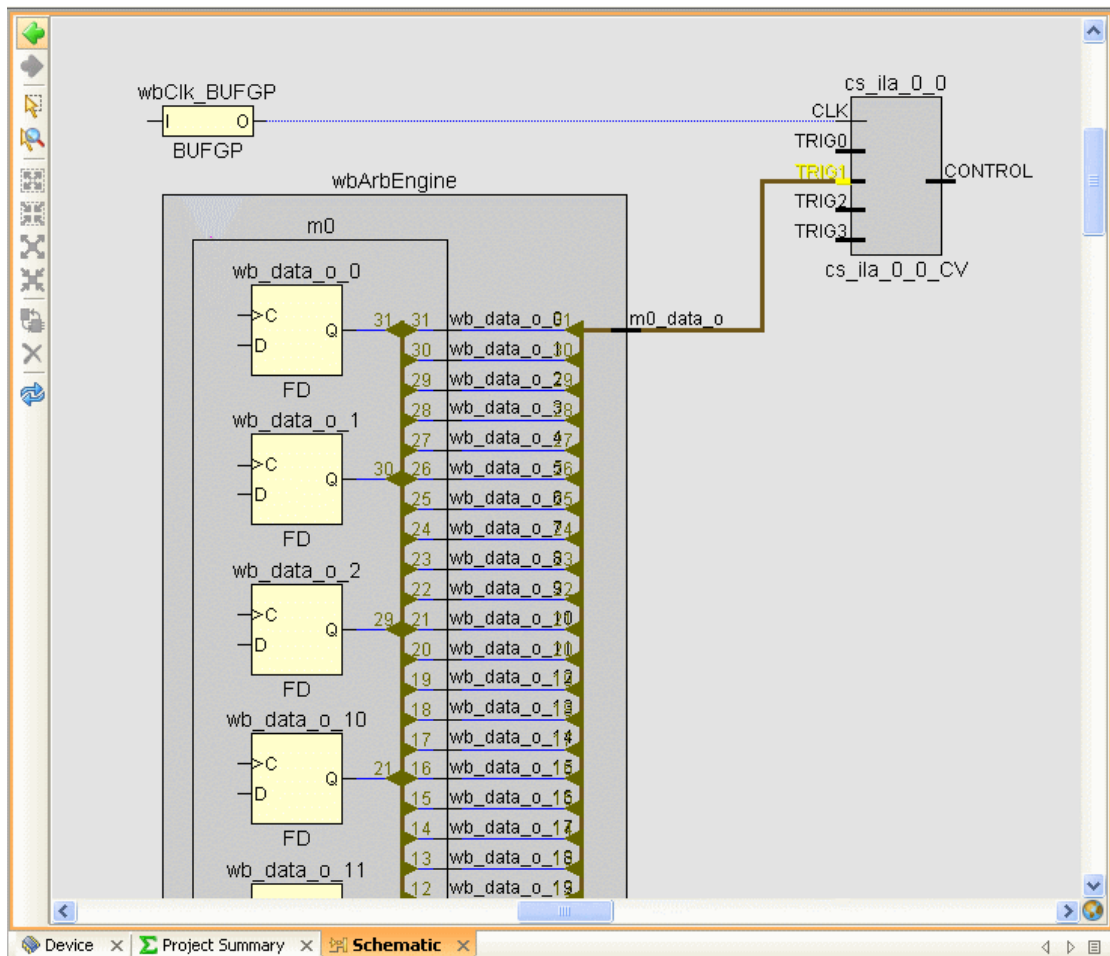

Figure 20: PlanAhead Expanded Schematic of TRIG1 Net

The trigger ports are connected to wishbone interface address control signals generated from the `wbArbEngine`. These signals are clocked by the clock signal `wbClk`.

Floorplanning is outside the scope of this tutorial, but it should be noted that inserting debug cores on critical logic could impact quality of results. Xilinx recommends that nets driven directly by the output pin of a flop be chosen for debug. It may also be necessary to use `AREA_GROUP` constraints (Pblocks in PlanAhead) to group the debug cores with critical logic being debugged to keep them placed close together and to minimize the timing impact of core insertion.

Other PlanAhead tutorials provide an introduction to floorplanning and assigning logic hierarchies to `AREA_GROUP` constraints for placement.

Step 6: Implement the Design

Step 6

At this point, you have:

- Created ChipScope debug cores
- Connected ChipScope debug cores to debug nets
- Changed debug core options from the defaults
- Generated the core netlists

You are now ready to implement the design.

More detailed information about implementing FPGA devices with PlanAhead is provided in other tutorials.

6-1. Implement the design.

6-1-1. In the Flow Navigator, click **Implement**.

The ISE Design Suite implementation is launched using the active constraint set and run strategy.

The PlanAhead environment reports the active results while implementation is running in the Compilation Log and Compilation Messages views.

This design takes approximately 20 minutes to implement. The Status Bar shows when implementation is complete. You could elect to read through the remaining steps rather than running implementation.

6-1-2. If prompted, click **Yes** to close the Netlist dialog box.

6-1-3. After implementation completes, select the **Open Implemented Design** option in the Implementation Complete dialog box.

The implemented design loads.

6-2. Highlight debug core logic placement.

6-2-1. In the Netlist view, press the **Ctrl** key to select both the cs_ila_0_0 and u_icon instances.

6-2-2. Right-click the instances, and select **Highlight Primitives > Cycle Colors**.

The logic in the debug cores is highlighted using different colors.

6-2-3. On the main toolbar, click Unhighlight All.

Step 7: Generate a Bitstream - Launch ChipScope Analyzer Step 7

You have now implemented the design and closed timing. Although this sample design might have timing failures, you can still generate a bitstream that can be used to program a device.

7-1. Generate a Bitstream for the implemented run.

7-1-1. In the Flow Navigator, select **Program and Debug > Generate Bitstream**.

The Generate Bitstream dialog box opens.

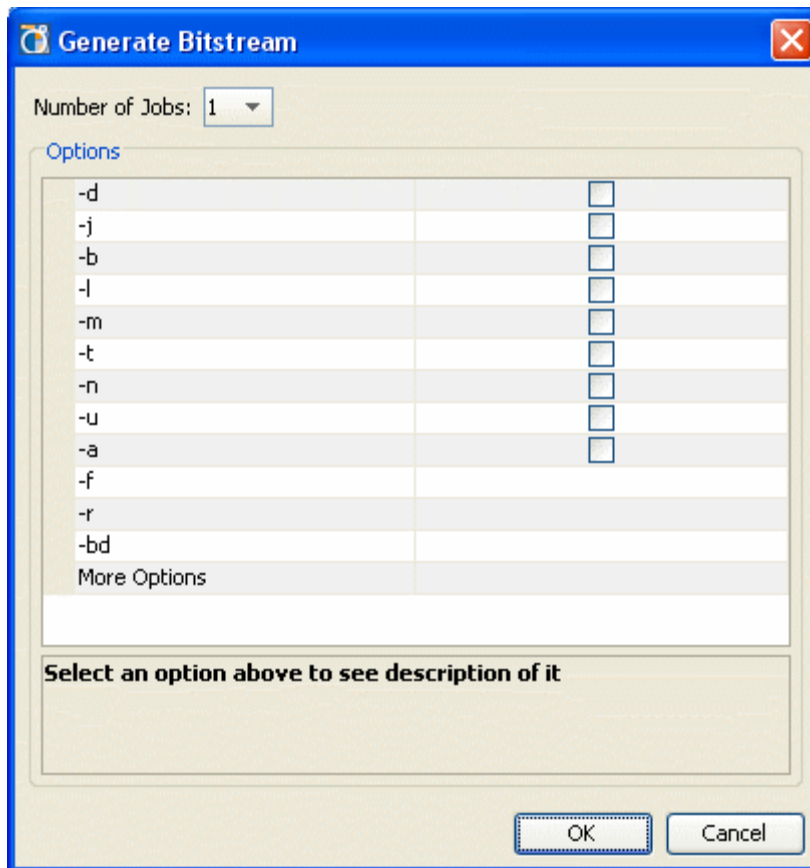

Figure 21: Generate Bitstream Dialog Box

7-1-2. Click **OK**.

7-1-3. In the BitGen Completed dialog box, click **OK**.

Once the Generate Bitstream command completes, the bit file can be downloaded to the FPGA device through the normal programming mechanisms.

You can now run ChipScope Analyzer.

7-2. Launch ChipScope Analyzer on the impl_1 bitstream.

7-2-1. In the Flow Navigator, select **Program and Debug > Launch ChipScope Analyzer**.

ChipScope Analyzer opens.

This step requires a functioning board connected to your computer. Because this is a demonstration design, this step does not work unless you have a FPGA device connected with which the Analyzer software can communicate.

7-2-2. Click **Close**.

ChipScope Analyzer closes.

Conclusion

In this tutorial, you:

- Used a sample design to set up and configure ChipScope debug cores.
- Selected nets to attach to trigger ports of the debug cores.
- Added selected additional nets to add to the debug cores.
- Changed the default settings for the implementation of debug cores.
- Implemented these Debug cores by calling CORE Generator to synthesize the configured debug cores and convert them from black boxes to implemented cores.
- Implemented the design and back-annotated placement and timing reports into the design.
- Ran BitGen.
- Ran the ChipScope Analyzer on the completed design.